

TAZ 2.0 USER MANUAL

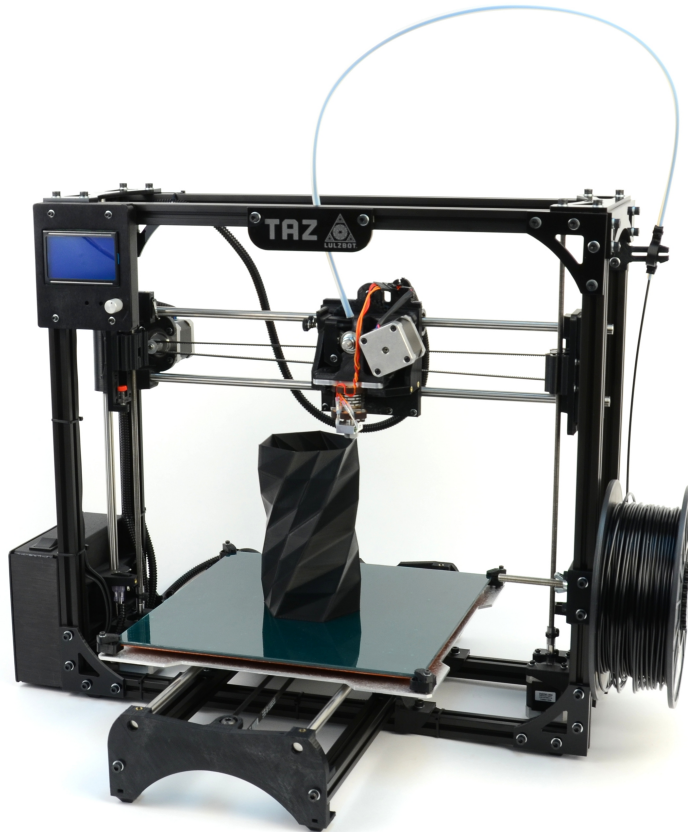

LULZBOT™

Aleph Objects, Inc.

LulzBot™ TAZ 2.0 User Manual

by Aleph Objects, Inc.

Copyright © 2013 Aleph Objects, Inc.

Permission is granted to copy, distribute and/or modify this document under the terms of the Creative Commons Attribution-ShareAlike 3.0 Unported license (CC BY-SA 3.0).

Published by Aleph Objects, Inc., 123 SW 12th Street, Loveland, Colorado, 80537 USA.

For more information, call +1-970-377-1111 or go to www.LulzBot.com and www.AlephObjects.com.

ISBN: 978-0-9893784-1-3

2013109

Contents

WARNINGS

Safety Information	xi
Read Me First!	xii
Hazards and Warnings	xii
1 Setup Your Printer	15
1.1 Hardware Setup	16
1.2 ABS & Acetone Solution Prep	32
2 Loading Filament	33
3 3D Printer Software	37
3.1 Software Overview	38
3.2 Installing Drivers	38
3.3 Printron	38
3.4 Using Printron	41
3.5 CAD and 3D Modeling Software	45
4 Your First 3D Print	47
4.1 Bed Leveling	48
4.2 Set Temperature	51
4.3 Load Filament	52
4.4 Home Printer	53
4.5 Z Print Height	55
4.6 Your First Octopus!	56
4.7 Remove Part	56
5 Slic3r	57
5.1 Introduction	58
5.2 Getting Slic3r	59
5.3 First Print	60

CONTENTS

5.4	Simple Mode	77
5.5	Expert Mode	86
5.6	Configuration Organization	114
5.7	Repairing Models	116
5.8	Advanced Topics	117
5.9	Troubleshooting	126
5.10	Slic3r Support	127
6	<i>Printing with the Graphic LCD</i>	129
6.1	GLCD Controller or Printron Host?	130
6.2	Multiple Connections	130
6.3	Putting Print Files On the SD Card	131
6.4	Printing with the Graphic LCD	131
7	<i>Maintaining Your 3D Printer</i>	137
7.1	Overview	138
7.2	Smooth Rods	138
7.3	Threaded Rods	138
7.4	PET Sheets	138
7.5	Hobbed Bolt	139
7.6	Software	139
7.7	Belts	139
7.8	Hot End	140
7.9	Electronics	140
8	<i>Advanced Usage</i>	141
8.1	Intro	142
8.2	Changing nozzles	142
8.3	ABS/Acetone Glue	143
8.4	Using 1.75mm Filament	143
9	<i>Hardware and Software Source Code</i>	147
10	<i>3D Printer Support</i>	149
10.1	LulzBot	150
10.2	Community	150
11	<i>Contact Information</i>	151
11.1	Support	152
11.2	Sales	152
11.3	Websites	152

CONTENTS

Index	· · · · ·	153
Glossary	· · · · ·	157

List of Figures

1.1	Axes movement directions	16
1.2	Locate the four Y axis bolts	17
1.3	Remove the four Y axis bolts	17
1.4	Locate the four Y axis mounts on the frame	18
1.5	Screw in and tighten the four Y axis bolts	19
1.6	Connect the two connectors found at the rear of the Y axis	20
1.7	Wrap and tighten a zip tie around the Y axis wires to the Y axis frame.	21
1.8	Connect the two connectors on the left of the print bed	22
1.9	Locate the two zip ties found in the bag with the manual	23
1.10	Tightly wrap the zip ties around the bed wires and through the strain relief slot	23
1.11	Remove the tool head screw	24
1.12	Mount the extruder tool head	25
1.13	Connect the two tool head connectors	25
1.14	Power and USB receptacles	27
1.15	Power supply	27
1.16	12V DC Power supply plug and receptacle	28
1.17	The power supply plug correctly plugged in	28
1.18	Filament Guide	29
1.19	Filament Guide Mount	30
1.20	Filament Guide Setting	30
1.21	Axes movement directions	31
1.22	End stop locations	32
2.1	Filament spool mount parts	34
2.2	Filament spool mount front	35
2.3	Filament spool mount back	35
2.4	Filament run through the guide	36
3.1	Printrun application for 3D printer control	39
3.2	Printrun	41
3.3	Printrun Functions	42
3.4	Movement Controls	43

LIST OF FIGURES

4.1	Z end stop trigger	48
4.2	Verifying the X and Y axis are square	50
4.3	Extruder idler release	52
4.4	Extruder filament slot	53
4.5	Nozzle height	54
4.6	Z end stop trigger	54
4.7	First layer adhesion	55
5.1	Configuration Wizard: Welcome Screen	62
5.2	Configuration Wizard: Firmware Type	63
5.3	Configuration Wizard: Bed Size	64
5.4	Configuration Wizard: Nozzle Diameter	65
5.5	Configuration Wizard: Filament Diameter	66
5.6	Configuration Wizard: Extrusion Temperature	67
5.7	Configuration Wizard: Bed Temperature	68
5.8	Configuration Wizard: End	69
5.9	Shapemith online CAD tool.	73
5.10	Plater	74
5.11	Minimug model.	75
5.12	STL file loaded.	75
5.13	Preferences.	77
5.14	Simple Mode: Print Settings.	78
5.15	An example of insufficient top layers.	79
5.16	Creating a vase from a solid model.	80
5.17	An example of an object printed with support material.	81
5.18	An example of brim.	82
5.19	Simple Mode: Filament Settings.	83
5.20	Simple Mode: Printer Settings.	84
5.21	Expert mode speed options.	87
5.22	Infill pattern settings.	89
5.23	Infill pattern: Line (344.51mm / 5m:20s)	89
5.24	Infill pattern: Rectilinear (350.57mm / 5m:23s)	89
5.25	Infill pattern: Concentric (351.80mm / 5m:30s)	90
5.26	Infill pattern: Honeycomb (362.73mm / 5m:39s)	90
5.27	Infill pattern: Hilbert Curve (332.82mm / 5m:28s)	90
5.28	Infill pattern: Archimedean Chords (333.66mm / 5m:27s)	90
5.29	Infill pattern: Octagram Spiral (318.63mm / 5m:15s)	91

List of Figures

5.30	Infill pattern comparison in a complex object. Left to Right: honeycomb, line	91
5.31	Infill patterns at varying densities. Left to Right: 20%,40%,60%,80%. Top to Bottom: Honeycomb, Concentric, Line, Rectilinear, Hilbert Curve, Archimedean Chords, Octagram Spiral	92
5.32	Infill advanced settings.	93
5.33	Retraction settings.	94
5.34	Skirt settings.	96
5.35	Cooling strategy.	97
5.36	Cooling advanced settings.	99
5.37	Support structure options.	100
5.38	Minimug model, tilted 45°.	101
5.39	Support infill pattern: Rectilinear	102
5.40	Support infill pattern: Rectilinear Grid	102
5.41	Support infill pattern: Honeycomb	102
5.42	Example of pattern angle rotated 45°.	103
5.43	Multiple extruder options - Printer Settings Tab (General). Note the two extruders defined in the left-hand pane.	104
5.44	Multiple extruder options - Printer Settings Tab (Extruder).	104
5.45	Plater with multiple filament options.	105
5.46	Multiple extruder options - Print Settings Tab.	106
5.47	Multiple extruder options - Tool change G-code.	106
5.48	Extrusion widths options.	108
5.49	Example model highlighting use case for variable layer heights.	109
5.50	Example with normal layer height.	110
5.51	Variable layer height options - Info.	111
5.52	Variable layer height options - Layers.	112
5.53	Example with variable layer height.	112
5.54	Example print with variable layer height.	113
5.55	Example with skipped layers.	113
5.56	Saving a profile.	115
5.57	Deleting a profile.	115
5.58	FreeCAD part repair.	116
5.59	Sequential printing options.	117
5.60	The clearance cylinder around an extruder.	118
5.61	Post-processing script option.	124

LIST OF FIGURES

5.62	Example post-processing script to display Slic3r environment variables.	124
5.63	Example post-processing script to print each line to output. . .	125
6.1	GLCD Info Screen	131
6.2	Main menu	133
6.3	Configuration Menu	135
6.4	Configuration Menu	136

WARNINGS
SAFETY INFORMATION

Read Me First!

READ THIS MANUAL COMPLETELY BEFORE UNPACKING AND POWERING UP YOUR PRINTER.

Hazards and Warnings

The TAZ 3D printer has motorized and heated parts. When the printer is in operation always be aware of possible hazards.

Electric Shock Hazard

Never open the electronics case when the printer is powered on. Before removing the electronics case cover always power down the printer and completely turn off and unplug the power supply and allow the power supply to discharge for at least 1 minute.

Burn Hazard

Never touch the extruder nozzle or heater block without first turning off the hot end and allowing it to completely cool down. The hot end can take up to twenty minutes to completely cool. Never touch recently extruded plastic. The plastic can stick to your skin and cause burns. The heated bed can reach high temperatures capable of causing burns.

Fire Hazard

Never place flammable materials or liquids on or near the printer when powered or in operation. Liquid acetone and vapors are extremely flammable.

Pinch Hazard

When the printer is in operation take care to never put your fingers in the moving parts including the belts, pulleys, or gears. Tie back long hair or clothing that can get caught in the moving parts of the printer.

HAZARDS AND WARNINGS

Static Charge

Make sure to ground yourself before touching the printer, especially the electronics. Electrostatic discharge can damage electronic components. Ground yourself by touching a grounded source.

Age Warning

For users under the age of 18, adult supervision is recommended. Beware of choking hazards around small children.

Setup Your Printer

1.1 Hardware Setup

1. Your printer has been calibrated and tested, however, after unpacking all of the components you will need to re-mount the Y axis onto the frame and connect the bed and Y axis connectors. You will also need to re-mount the extruder tool head. Please follow the steps completely to make certain that the extruder tool head and Y axis are re-mounted correctly. You will then be on your way to your first print. Use Fig. 1.21 to see which direction the three axes move, as the following instructions will reference the X, Y, and Z axes.

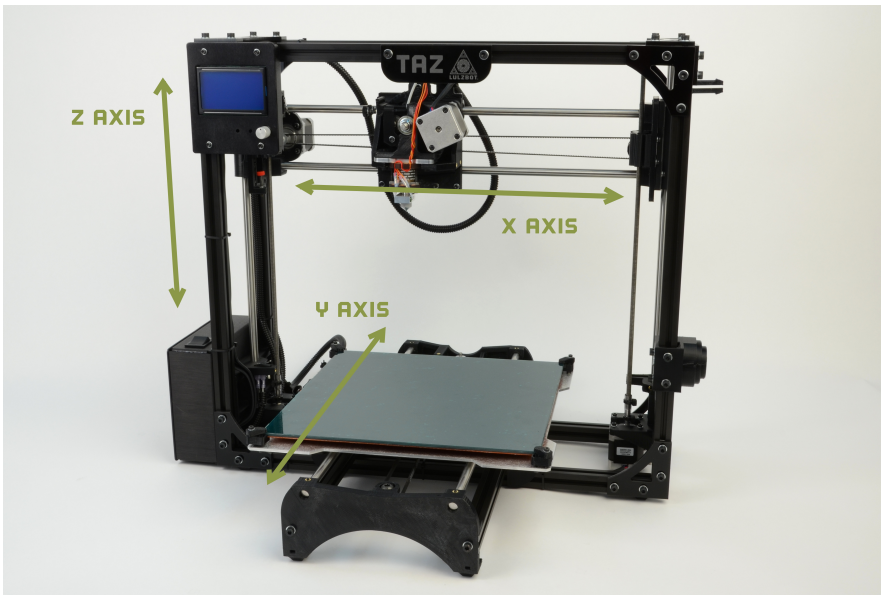

Figure 1.1: Axes movement directions

2. Place the TAZ frame and Y axis assembly on a flat and level surface. Move to the Y axis assembly and find the four Y axis bolts. The four bolts located on the Y axis aluminum frame bars, have large plastic knobs that allow the bolts to be easily turned by hand (Fig. 1.2, page 17). Turning counter clock-wise, remove each of the four Y axis bolts and set aside (Fig. 1.3, page 17).

1.1. HARDWARE SETUP

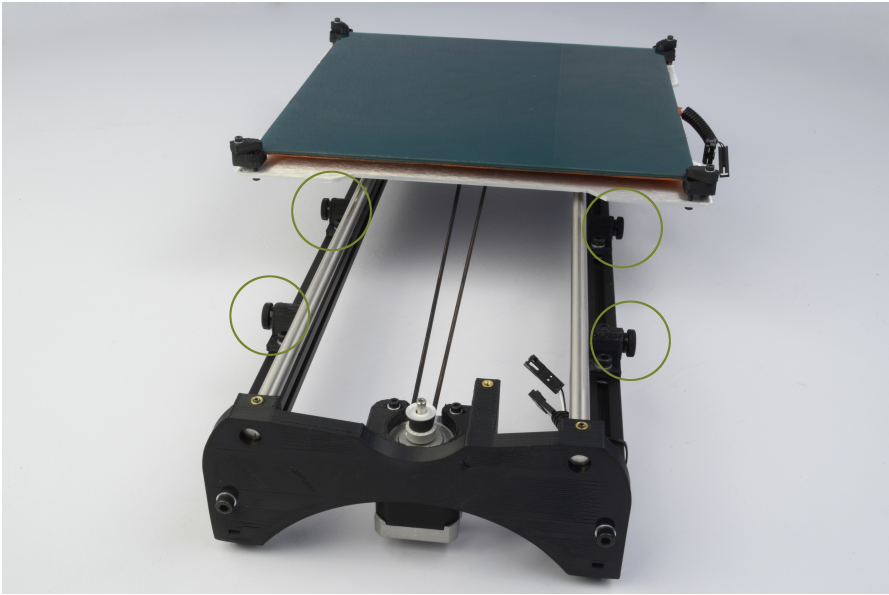

Figure 1.2: Locate the four Y axis bolts



Figure 1.3: Remove the four Y axis bolts

3. On the TAZ frame locate the four Y axis mount brackets shown in Fig. 1.4 (pg. 18). With the print surface facing up and the stepper motor end of the Y axis facing back, slide the Y axis assembly in between the Y axis mount brackets. The four Y axis mount brackets will line up with the Y axis bolt holes on the Y axis assembly. Thread the four Y axis bolts through the brackets, into the Y axis assembly (Fig. 1.5, page 19). Before completely tightening the Y axis bolts make sure the Y axis aluminum bars are pushed down against the TAZ frame lower bars. You can do this by slightly tilting the printer, on the side edge, enough to lift the feet of the Y axis off of the table. The weight of the Y axis will seat it against the TAZ frame. While the printer is slightly tilted tighten the four Y axis bolts. The printer can now be set flat on the table.

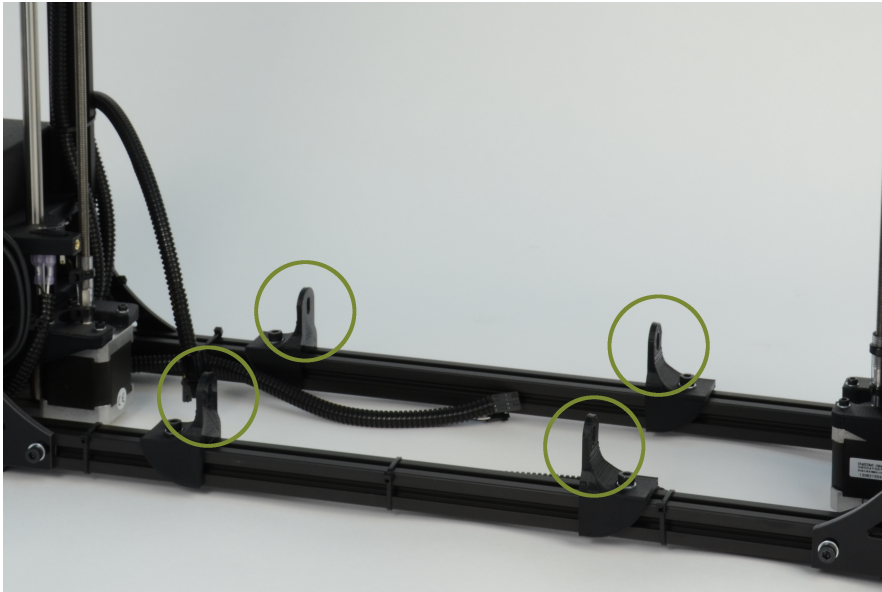

Figure 1.4: Locate the four Y axis mounts on the frame

1.1. HARDWARE SETUP

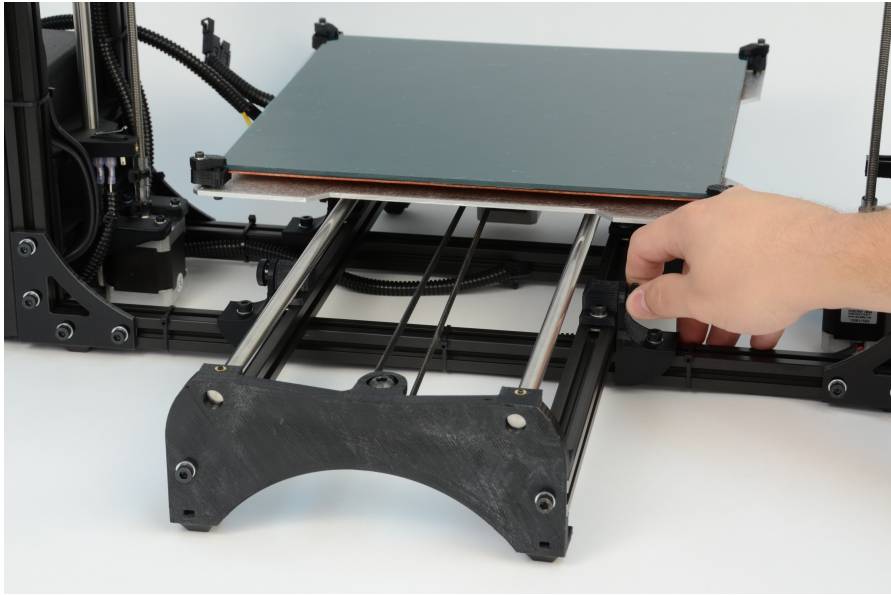

Figure 1.5: Screw in and tighten the four Y axis bolts

4. The next step of installing the Y axis is connecting the print surface connectors and Y axis connectors. Pull the print bed completely to the front of the printer to get access to the Y axis connectors. You will find matching male and female 4 pin stepper motor connectors and two pin end stop connectors. Connect the matching male and female connectors (Fig. 1.6, page 20); make sure the connector's lock clicks to be sure that it is secured.

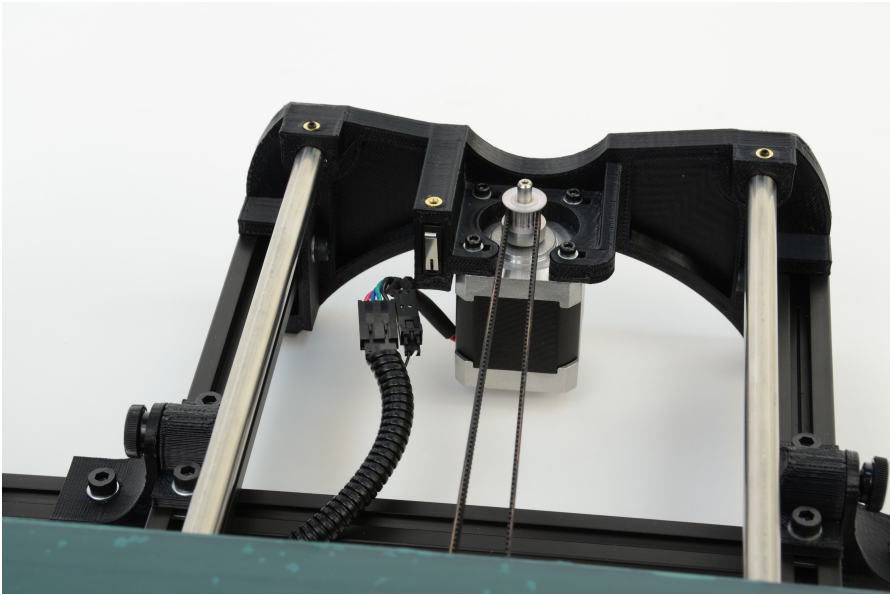

Figure 1.6: Connect the two connectors found at the rear of the Y axis

5. Locate one of the three small black zip ties that are included in the documents bag. Wrap and tighten the zip tie around the Y axis wiring and the black Y axis frame extrusion as shown in figure 1.7 (page 21).

1.1. HARDWARE SETUP

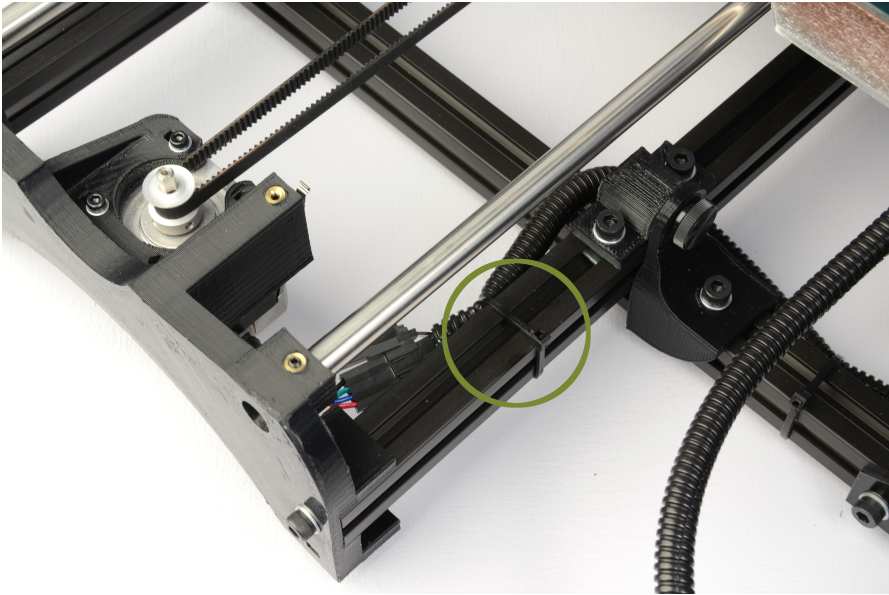

Figure 1.7: Wrap and tighten a zip tie around the Y axis wires to the Y axis frame.

6. Locate the two connectors to the left of the print bed. Connect the matching female and male large two pin heat bed connectors and the small two pin thermistor connectors, again making sure the connectors lock(Fig. 1.8, page 22).

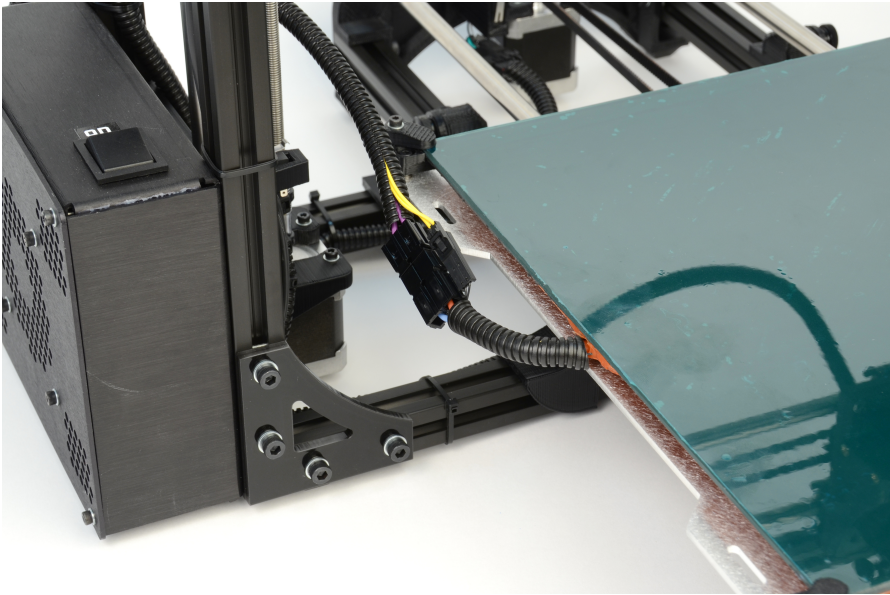

Figure 1.8: Connect the two connectors on the left of the print bed

7. Locate the other two small black zip ties that are included in the documents bag (Fig. 1.9, page 23). Wrap the two zip ties through the slot, located on the left rear of the aluminum bed plate, and around the print bed wires (Fig. 1.10, page 23). Tighten the zip ties snug so the wire cannot move freely. Cut off the excess end of the zip ties with the needle nose pliers included in the tool bag.

1.1. HARDWARE SETUP

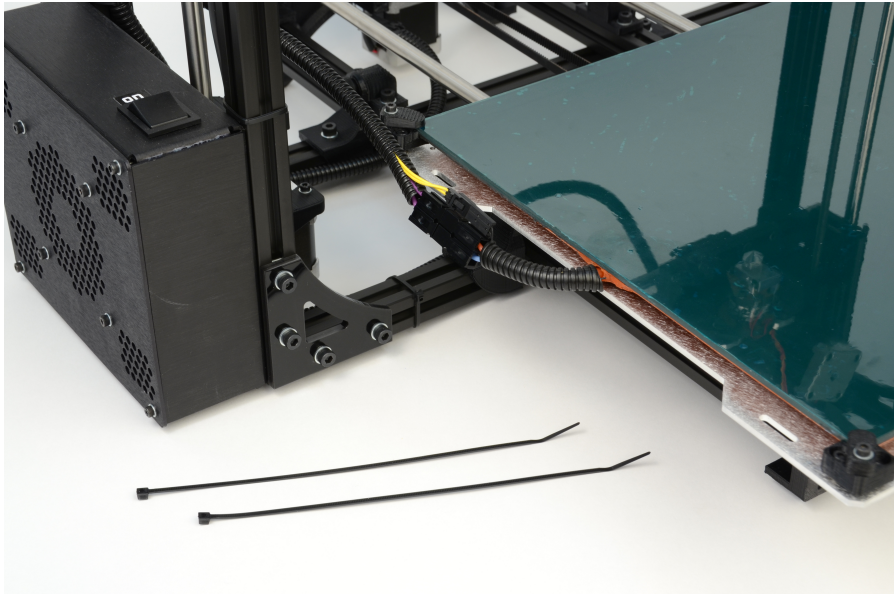

Figure 1.9: Locate the two zip ties found in the bag with the manual

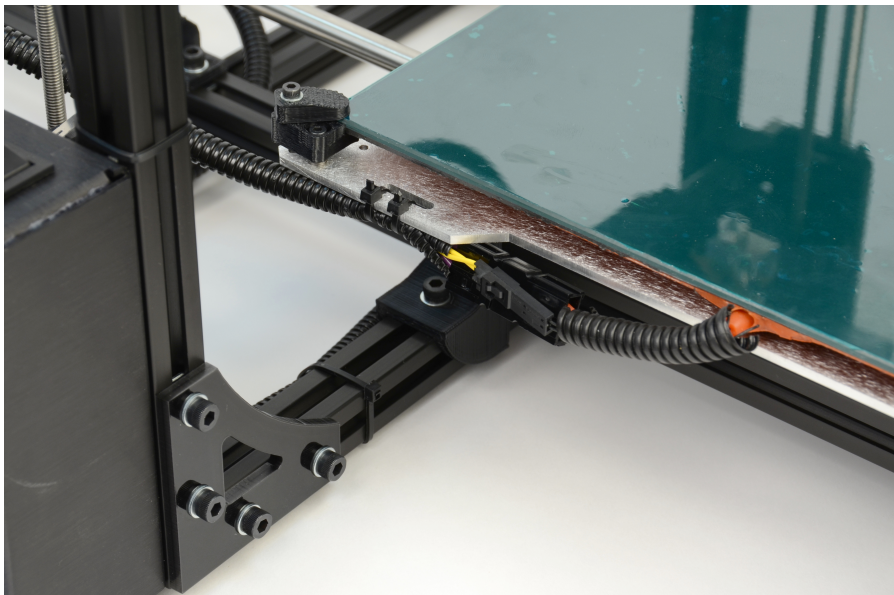

Figure 1.10: Tightly wrap the zip ties around the bed wires and through the strain relief slot

8. Before proceeding make sure that the four red shipping clamps on the Z axis smooth rods have been removed.
9. Move the X axis carriage to the center of the smooth rods. If you have not already done so, remove the foam from between the X axis carriage and the left hand X axis end. Locate and remove, with the 2.5mm hex driver, the tool head 3mm screw in top center of the X axis carriage (Fig. 1.11, page 24). Place the extruder tool head mount onto the X axis carriage bottom first. The extruder mount will slide into the bottom portion of the carriage and self center (Fig. 1.12, page 25). Use the included 2.5mm driver and the previously removed 3mm screw to secure the extruder tool head onto the X axis carriage.



Figure 1.11: Remove the tool head screw

10. Connect the stepper motor and the hot end to the existing wiring harness located at the top of the X axis carriage. Connect the matching male and female connectors with red/orange wires for the hot end and the other male and female connectors for the extruder motor (Fig. 1.13, page 25). Make sure the connector locks click to be sure that the connections are secure.

1.1. HARDWARE SETUP

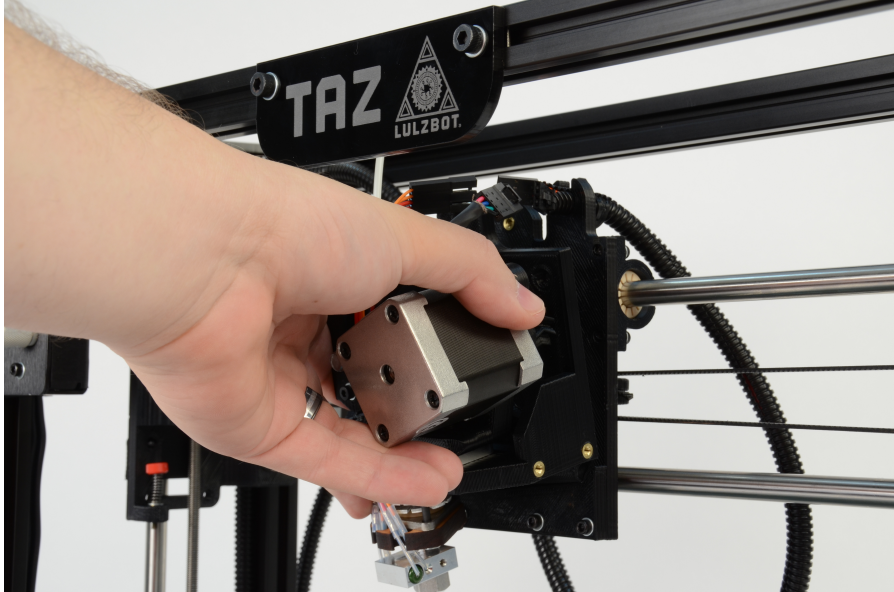

Figure 1.12: Mount the extruder tool head

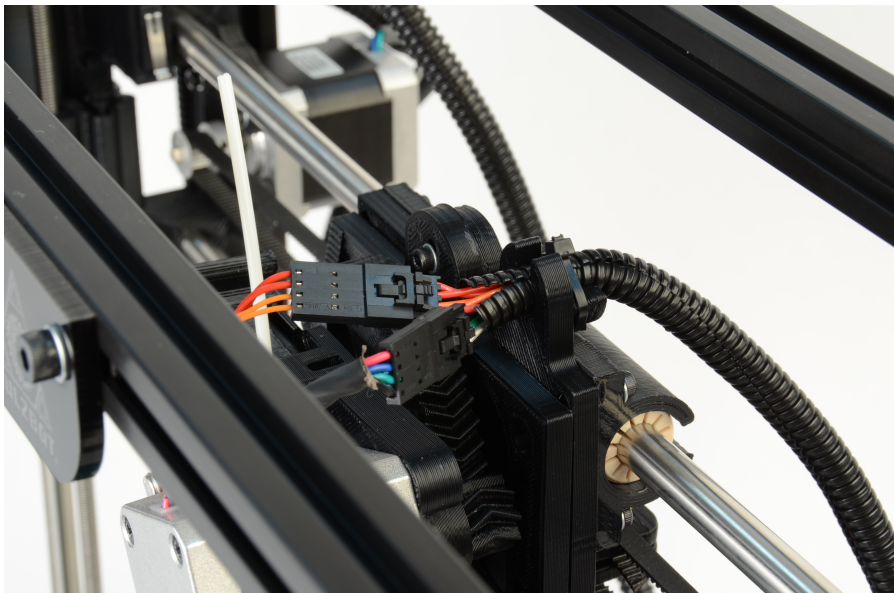

Figure 1.13: Connect the two tool head connectors

11. Now that the Y axis is mounted and the extruder tool head is installed you should set your printer on a stable, flat, and level surface large enough for extra space around the printer. Make sure your printer work space is clear of anything that could obstruct the movement of the printer. Move the Y axis to the back of the printer to ensure unobstructed movement of that axis. **Make sure there are no flammable fabrics or liquids near the printer space.** It is also best to not put your printer near a drafty window or air conditioner vent.
12. Unwrap the power supply and USB cables.
MAKE SURE THE POWER SUPPLY IS COMPLETELY UNPLUGGED BEFORE MOVING ON TO THE NEXT STEP.
13. Locate the power supply and USB receptacles along the back of the TAZ electronics enclosure (Fig. 1.14, page 27). Locate the power supply and the included AC power cable (Fig. 1.15, page 27). Locate the DC power cable plug on the power supply. Connect the DC locking plug into the DC connector on the TAZ electronics enclosure (Fig. 1.16, page 28). The plug is keyed which may require rotating the plug until the keys line up and the plug can be pushed in. Once you have pushed in the plug turn the locking sleeve clockwise until it is tight against the electronics enclosure (Fig. 1.17, page 28).

1.1. HARDWARE SETUP

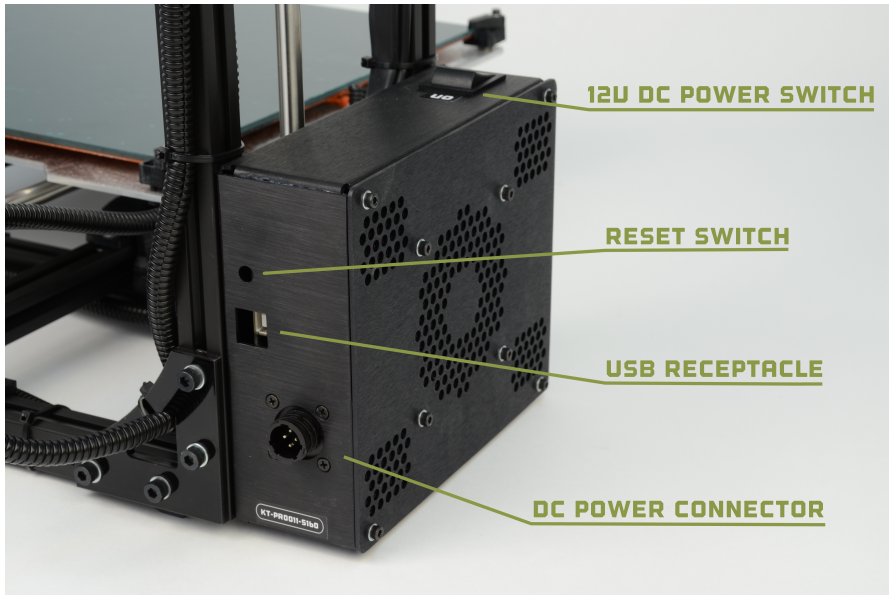

Figure 1.14: Power and USB receptacles



Figure 1.15: Power supply



Figure 1.16: 12V DC Power supply plug and receptacle



Figure 1.17: The power supply plug correctly plugged in

1.1. HARDWARE SETUP

14. Locate, on the right of the power supply, the red AC voltage switch. Depending on your location you will need to change the AC voltage switch to 115V or 230V. North America is generally 115V and the majority of other regions are 230V. You can find general voltage by country at wikipedia.org/wiki/Mains_electricity_by_country. Make sure that when plugging in the AC power cable it is directly plugged into the wall and **not** into a power strip. The TAZ 3D printer can potentially pull more current than the power strip will support and may lead to undesirable performance.
15. Plug in the USB cable, B plug (square plug) side, into the USB receptacle on the printer electronics. Plug the other end of the USB cable, A plug side, into your computer.
16. Locate the filament guide with attached PTFE tube (Fig. 1.18, page 29). The filament guide attaches to the filament guide mount which can be found on the top right side of the printer frame (Fig. 1.19, page 30). The filament guide easily pops on to the guide mount as shown in figure 1.19 (pg. 30).



Figure 1.18: Filament Guide

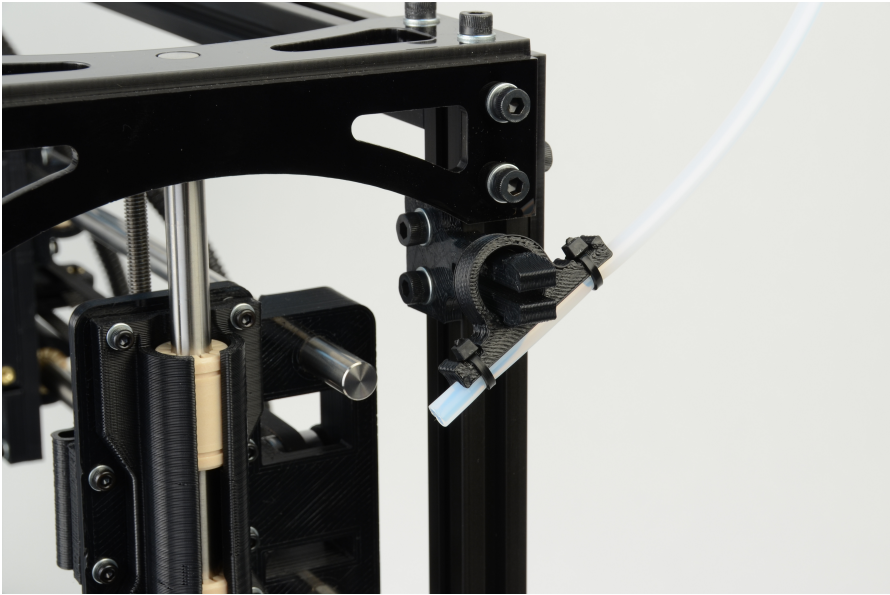

Figure 1.19: Filament Guide Mount

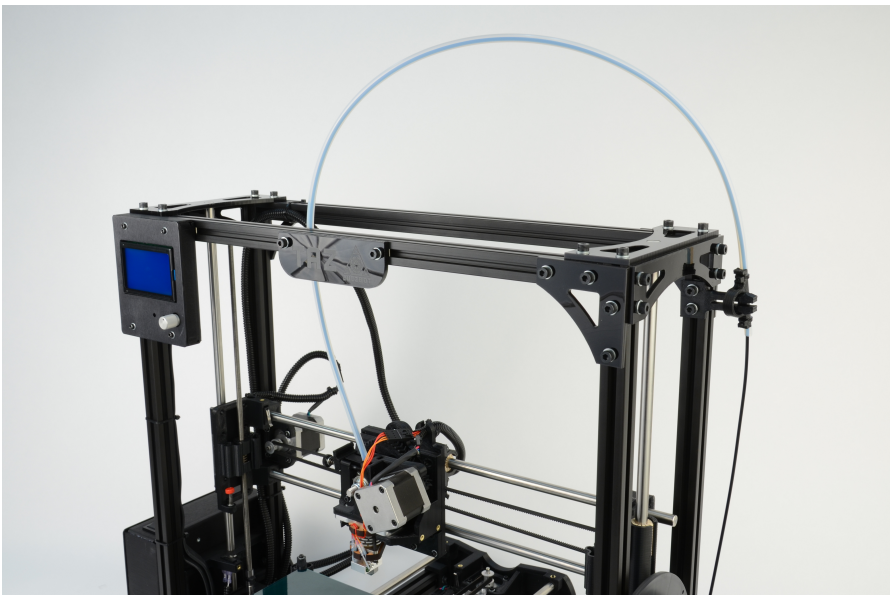

Figure 1.20: Filament Guide Setting

1.1. HARDWARE SETUP

17. Before moving forward you should become familiar with the TAZ Cartesian type system. The printer moves in three axes: X, Y, and Z (Fig. 1.21, page 31). These three axes allow the tool head to move to any point within the print area. Note the location of the mechanical end stops which are small switches located at the home point of each axis (Fig. 1.22, page 32). Each end stop switch allows the printer to find the 0, the origin, or starting point, of each axis. The mechanical end stops should never be blocked during the initial homing function or during a print.

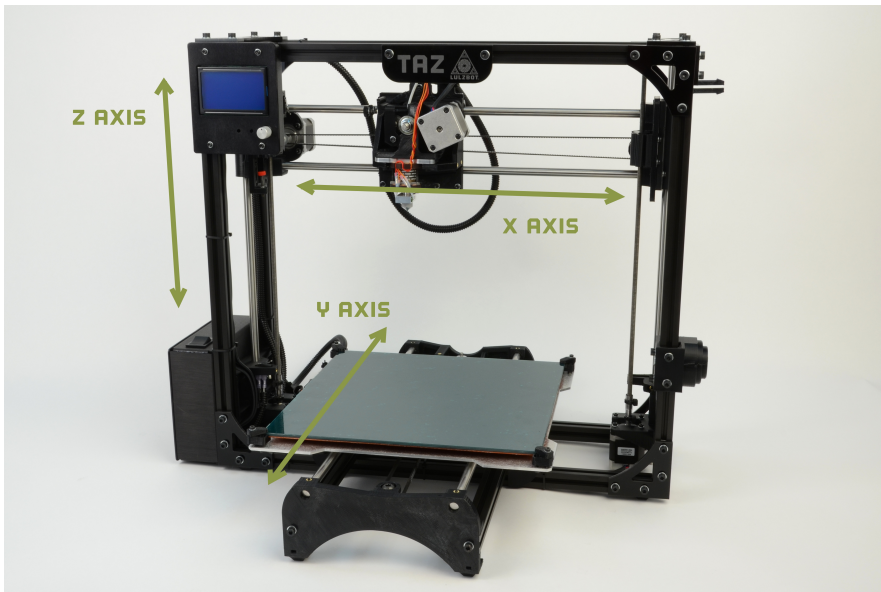

Figure 1.21: Axes movement directions

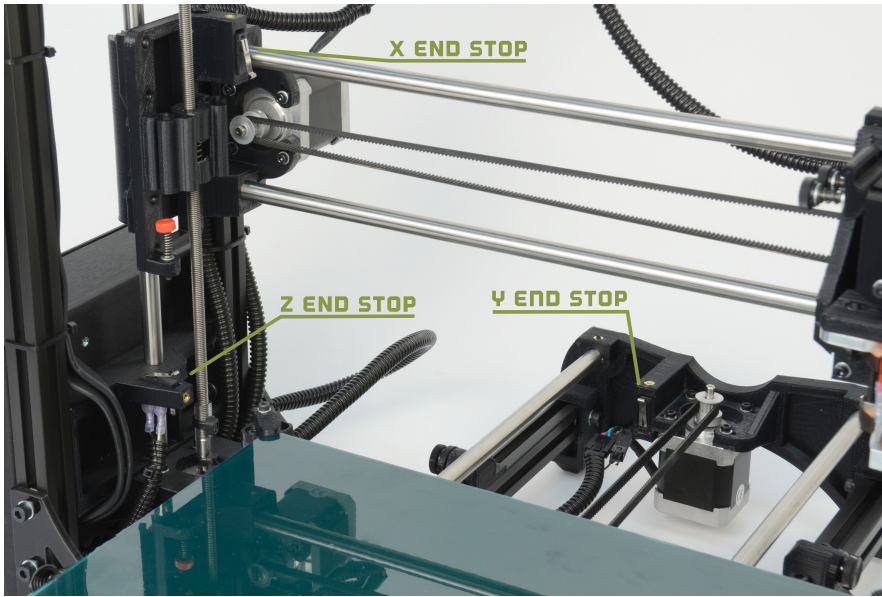

Figure 1.22: End stop locations

1.2 ABS & Acetone Solution Prep

Please refer to section 8.3 (page 143) for instructions in preparing the ABS/Acetone Glue for use when printing with ABS. As it will take some time to dissolve the ABS into the acetone it may now be a good time to make the solution. If you are printing with PLA, the ABS and Acetone solution is not needed.

Loading Filament

Loading Filament

Before you start printing you will need to load a reel of filament onto the reel holder. If mounted correctly the reel holder will keep the filament reel rotating smoothly. The reel holder is meant to work with 1kg and 5lb plastic filament reels but can be modified to work with other reel and spool types.

1. Locate the filament reel spindle and unthread and remove the wingnut and washer (fig. 2.1, page 34). Set the filament reel with the filament feeding counter clockwise. Insert the reel spindle into the plastic filament reel.

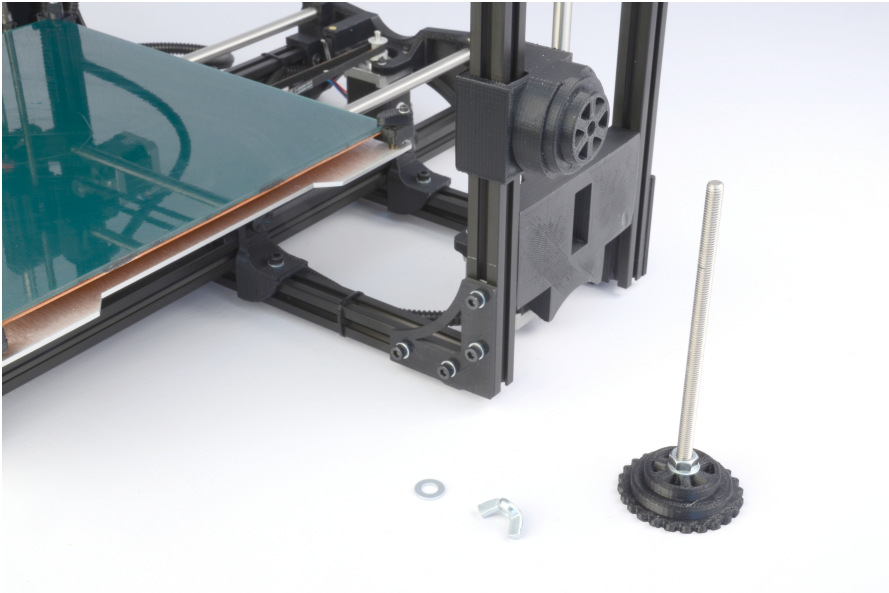

Figure 2.1: Filament spool mount parts

2. Thread the reel spindle into the filament holder mounted on the lower right hand side of the TAZ 3D Printer (fig. 2.2, page 35). Turn the spindle handle clockwise until it snugs up against the reel and then turn it back one quarter of a turn. This will allow the reel to easily turn but not turn too freely that it would allow the filament to unravel.
3. Slide the washer onto the end of the spindle on the back of the reel mount. Thread the wing nut onto the spindle end and loosely up against the nut on the back of the reel mount (fig. 2.3, page 35). While

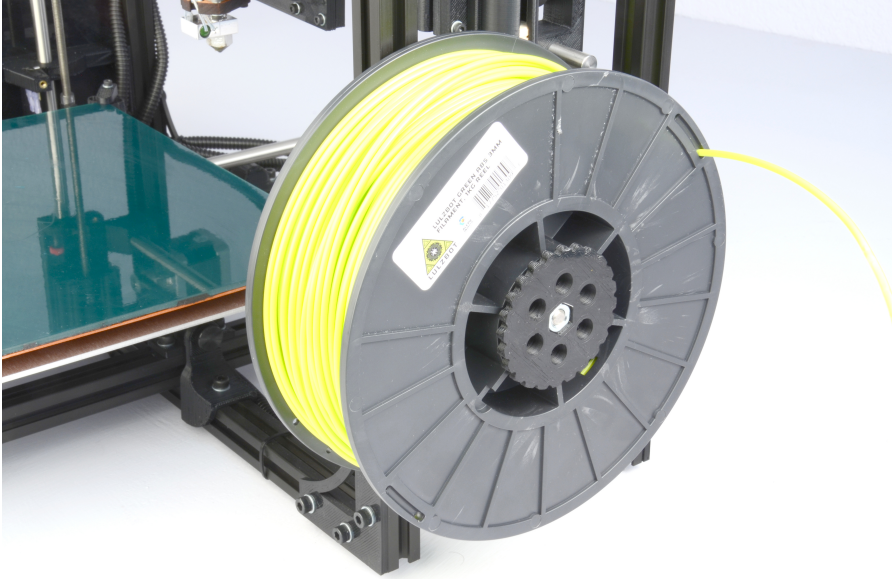

Figure 2.2: Filament spool mount front

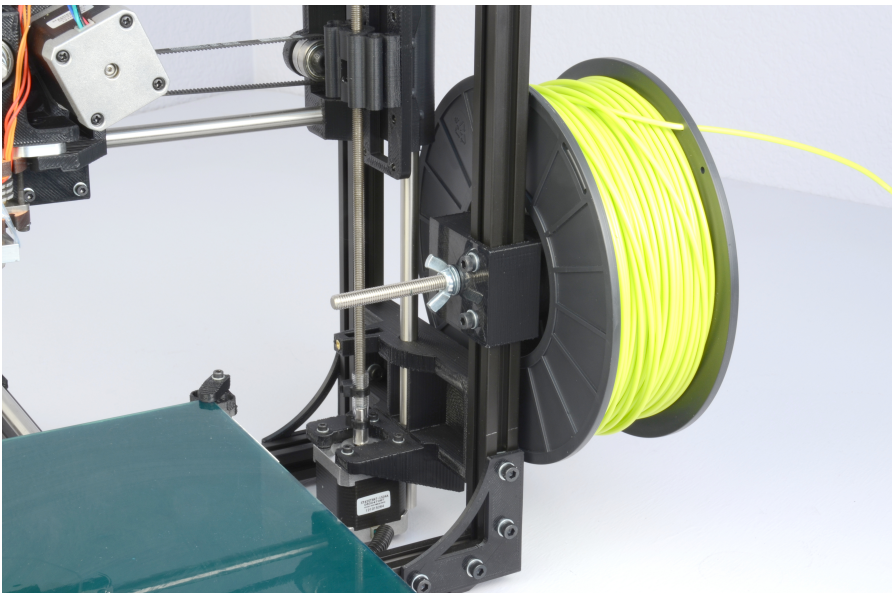

Figure 2.3: Filament spool mount back

Loading Filament

holding the reel spindle handle in place tighten the wing nut against the nut on the back of the reel mount. This will keep the tension you set at the handle in place. If you need to adjust the tension, loosen the wingnut, adjust the handle tension, and retighten the wingnut.

4. Feed the end of the filament through the filament feed tube. The Filament should now be threaded through the PTFE sleeve and exiting near the extruder (fig. 2.4, page 36).

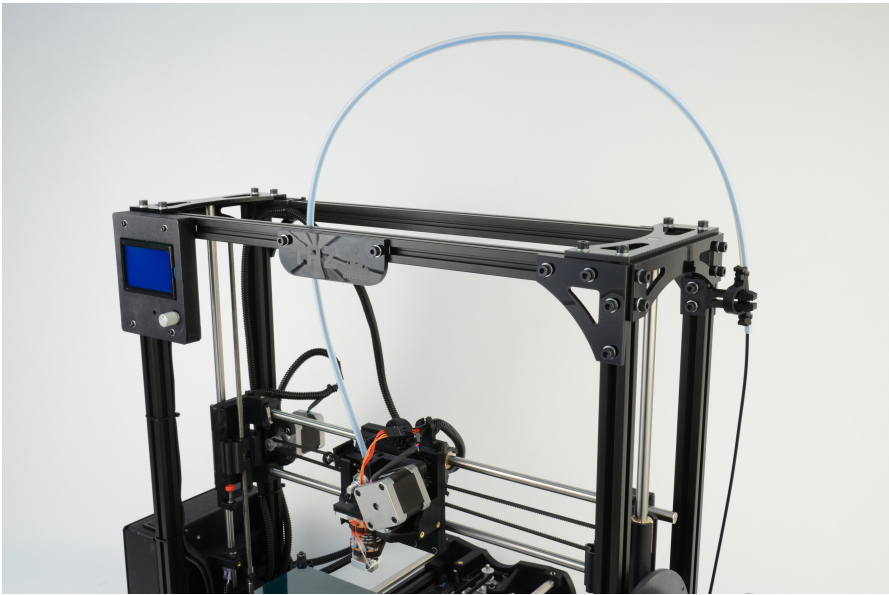

Figure 2.4: Filament run through the guide

5. When changing filament, slide the opposite end of the filament through one of the holes in hub of the filament spool. This will keep the filament from unwinding from the spool (fig. 2.2, page 35).

3D Printer Software

3.1 Software Overview

Aleph Objects, Inc., the maker of the LulzBot TAZ, completely supports free/libre hardware and software. Along with the TAZ being a free/libre hardware design, it has been tested to work with 100% free/libre software. Our source code and design files are hosted on our development server found at <http://devel.lulzbot.com>. To operate your desktop 3D printer you will need to install a few software packages onto your PC. You will need a 3D printer host, an `.STL` to `.gcode` generator, and optional CAD or 3D modeling software.

All of the following free/libre software packages are available for GNU/Linux, Windows, and Apple OS X. However, we highly recommend using these programs on GNU/Linux.

The required software can be found in the Support/Downloads section at LulzBot.com/support/downloads. You will also find instructions there for installing each program onto your PC. You can also find downloads specific to the TAZ 3D printer on the TAZ product page.

3.2 Installing Drivers

Linux and Mac OSX users will not need to install a driver to communicate with the TAZ 3D printer. Windows users will. The drivers can be downloaded from LulzBot.com/support/downloads. A visual guide showing the driver installation process can be found in our download section as well.

3.3 Printrun

Website: <http://www.github.com/kliment/Printrun>

The host software, Printrun, is used to start up and control your 3D printer (Fig. 3.2, page 41). The host controls include: setting the extruder and print surface temperatures, manual control of each axis, and manual extrusion. The host is also where you can push print files (`.gcode`) to the 3D printer or load print files from the SD card for printing out model designs.

3.3. PRINTRUN

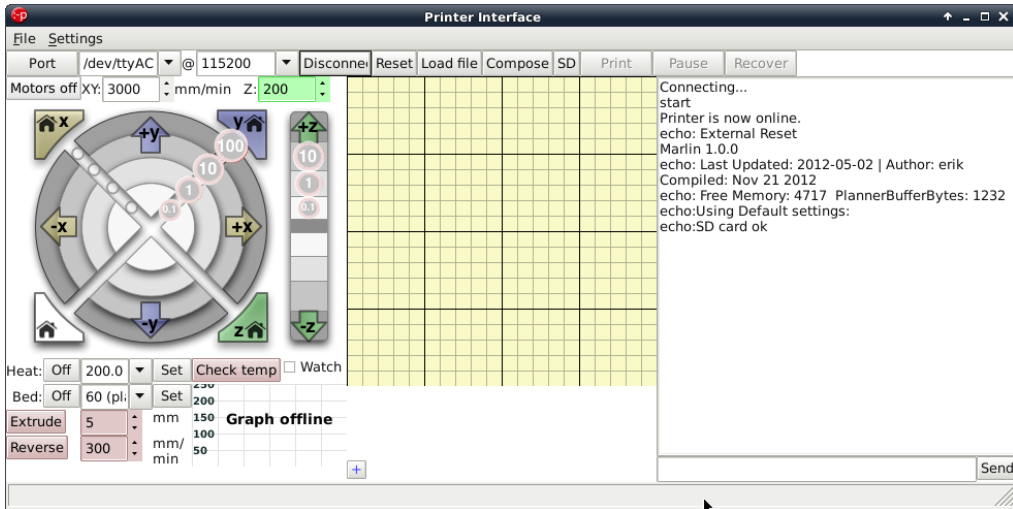

Figure 3.1: Printrun application for 3D printer control

Installing Printrun

Printrun contains several different applications that can be used to control the TAZ 3D printer. It can be installed on Windows, Mac OSX and Linux based computers. We recommend using Pronterface, the graphical user interface for printrun, when setting up or troubleshooting the 3D printer. `Pronsole` allows printing from the command line, and can be used for scripting and some automation. `Plater` allows you to arrange and combine several STL files into one. More information on the other programs within the Printrun package can be found at <https://github.com/kliment/Printrun>. Printrun can be downloaded from LulzBot.com/support/downloads. Download the version for your operating system and extract. You will need an archive manager to extract the files. If you do not have one installed we recommend using 7-zip, which can be downloaded for free at www.7-zip.org.

Windows Instructions

- Once downloaded, extract the `dist` folder to a location of your choice. You can rename the `dist` folder if you like. Double click `pronterface.exe` to run Pronterface.

Mac OSX Instructions

- Once downloaded, extract the `dist` folder to a location of your choice. Once extracted, double click the `pronterface-mac-Mar2012.app` file to install.

Linux Instructions

Debian—Ubuntu

- Once downloaded, extract the `dist` folder to a location of your choice. You will need to ensure that the following dependencies are met. They are listed in the `README.md` file. You can use this command to install the dependencies:
`sudo apt-get install python-serial python-wxgtk2.8
python-pyglut python-tornado python-setuptools
python-libxml2 python-gobject python-pip avahi-daemon
libavahi-compat-libdnssd1` followed by: `pip install -r
requirements.txt` Open the `Printrun-source` folder in a terminal and enter the following command: `sudo python setup.py
install`. Run `Printrun` by issuing the following command: `python
pronterface.py`

Fedora

- Use this command to install `Printrun` from the official sources: `sudo
yum install printrun`

Archlinux

- Use this command to install `Printun` from AUR: `yaourt printrun`

3.4 Using Printron

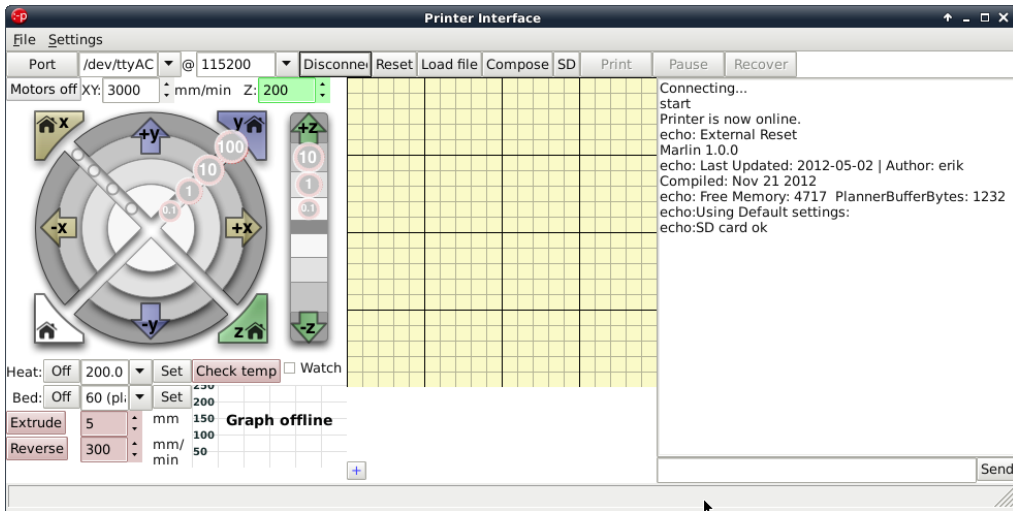

Figure 3.2: Printron

Printron is used to control the printer from a computer. It is divided into 4 main parts: The buttons over the top are used to connect to the printer, load files and start & stop prints.

The movement controls are on the left hand side, with the G-code preview window in the center and the Log window and Terminal command entry box on the right hand side (Fig. 3.2, page 41).

Connecting to the TAZ 3D Printer

To start up the printer, first you will need to connect to the printer with Printron. Make sure you have connected the USB cable from your PC to the printer before launching Printron. If not, close Printron, connect the USB cable, and relaunch Printron. To connect to the printer, select the correct port by using the drop down arrow and selecting the active port, generally /dev/ttyACM0). On other operating systems the port may be named such as COM1 or tty.usbserial-USB-ID. The Port button will refresh the Port listing. Once selected choose the default 115200 baud rate and press **Connect**. Printron will open a connection to the printer and display firmware information in the Log window.

In the text output window you will see multiple return lines. If you see `Printer is now online` you have successfully connected to the printer. The printer control buttons on the left will also darken and become clickable after connecting. If nothing is displayed in the Log window verify you have the correct port and connection speed selected. When you need to disconnect the printer simply press the `Disconnect` button.

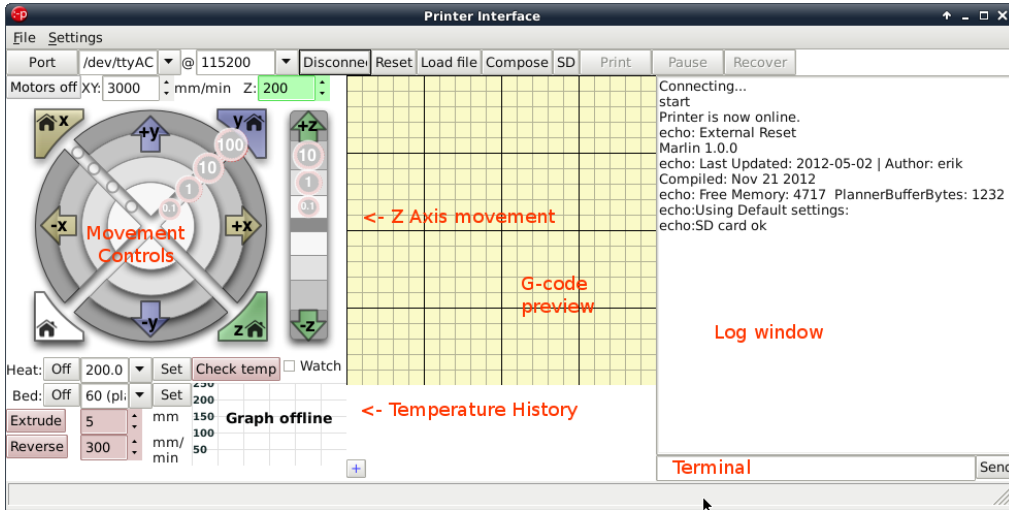

Figure 3.3: Printrun Functions

Movement

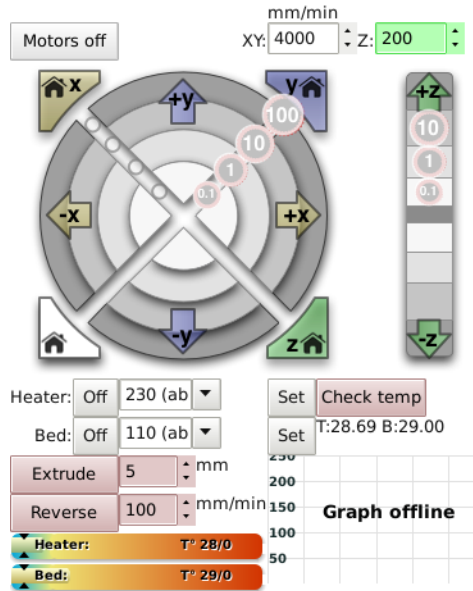

Figure 3.4: Movement Controls

Motors off

The TAZ 3D printer can be moved on all three axes independently. If you would like to do so by hand, use the **Motors off** button to unlock all the stepper motors. Once unlocked they can be moved by hand. Keep in mind that there is no positional feedback, so if you move an axis you will need to re-home in order to re-establish the hot end's position.

mm/min ZY:/ Z:

These settings control the manual jog speeds when driven with Pronterface. Use caution when changing these figures. Moving the axes too fast can cause the printer to lose steps. If that occurs with the Z axis, it can potentially cause the Z axis to become out of square.

Homing

Caution: when homing, the axis will continue to move in the negative direction until the end stop switch is activated. If the printer is ever transported make sure the end stop switches are clear before resuming printing. If an axis has missed an end stop and is continuing to try to move in the negative direction, immediately turn the power switch to the off position.

Each axes can be homed either individually or together. Press the **Home X** button to move the X axis to the left until it activates the end stop. Once the X axis end stop is activated, the X axis carriage will 'bounce'- it will move over and move back to the home position more slowly. Press the **Home Y** button to home the Y axis. The Y axis platform will move away from you towards the rear of the printer. **DO NOT press the Home Z button to home the Z axis or the Home All button at this time.** Make sure that you home the printer immediately after power up. The printer will not know where the origin point is until each axes has been homed. Moving prior to homing can be risky since the 3D printer will not know it's initial location.

X/Y/Z Axes Movement Controls

Prior to moving the X, Y or Z axis, make sure that you home each axis. The X, Y and Z axes can be moved utilizing the circular movement controls. Each axis can be moved in either fine moves or large moves, ranging from 0.1mm to 100mm. For example, to move the **Y Axis** towards you, move your mouse to the **+y** section until both the **+y** and the **100** are highlighted then select that ring section. To move the **Y axis** away from you, move your mouse to the **-y** section until both the **-y** and the **100** are highlighted then select that ring section. The X axis can be moved in a similar fashion.

DO NOT press the Home Z button to home the Z axis or the Home All button at this time. The Z axis movement control operates similarly, but the movement scale is different. The Z axis will move in 0.1mm, 1mm and 10mm increments. The top half of the movement bar will move the Z axis up, by the selected units, while the lower half will move the Z axis down, by the desired units.

3.5 CAD and 3D Modeling Software

Currently LulzBot is not distributing a CAD or 3D modeling software package. However, there are multiple free/libre software packages available. Other common non-free CAD and 3D modeling software are also capable of exporting the required .STL files.

On some CAD and 3D modeling software you will need to select millimeters as the output unit. If possible it is best to build your 3D design in metric units rather than imperial units. Slic3r requires .STL files sized in millimeters. If an .STL with inches as units is loaded into the Slic3r, the model will be scaled much smaller than expected. You can scale the model by 2540% to compensate. The software listed below outputs millimeters as the unit by default.

FreeCAD

Website: <http://free-cad.sourceforge.net>

Although still in development, FreeCAD is a great free/libre CAD application. Containing a full GUI for building CAD models, FreeCAD is capable of creating simple to complex designs. STL files can also easily be exported for use with 3D printing. FreeCAD is available for GNU/Linux, Windows, and Mac. The latest development version is recommended.

OpenSCAD

Website: <http://openscad.org>

OpenSCAD is another free/libre CAD software; however, different than FreeCAD, it is script based. Rather than using a GUI to generate CAD designs, OpenSCAD CAD designs are created using script based renderings. Users with programming experience would find this very useful. Also, OpenSCAD uses a simple script language that is easy to learn for users with little or no programming experience.

Blender

Website: <http://blender.org>

The most widely used Free/Libre 3D modeling software, Blender is well documented with tutorials available on the Blender.org website. Numerous video tutorials can be also found online.

Shapesmith

Website: <http://shapesmith.net>

Shapesmith is a web based 3D modeling software. This means there is no required software to get started designing models. Shapesmith is also a great choice for anyone just starting out in CAD/ 3D modeling.

Your First 3D Print

4.1 Bed Leveling

Make sure you take the time to go through the following procedure to help ensure that your prints are consistent and trouble free. Make sure to first read the instructions for using the Printron software. Connect to the printer as described in the Printron software section. Once Pronterface is connected to the printer use the homing buttons to home the X and Y axis. **Do not use the Home Z button until after the Z axis End stop has been adjusted. Make sure that the red shipping clamps on the Z axis smooth rods have been removed before continuing.**

Rough Adjustment of the Z Axis End Stop Trigger

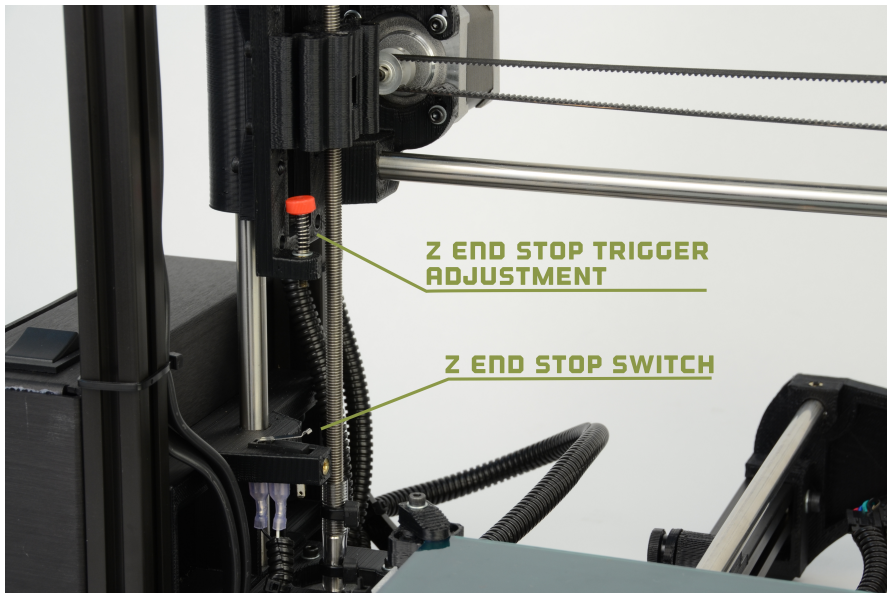

Figure 4.1: Z end stop trigger

Before using the home Z button or the home all button you will need to adjust the Z axis endstop trigger. The red end stop trigger is on the far left of the printer, mounted on the X-axis motor mount. Once connected to the TAZ 3D printer in Pronterface, Rotate the Z axis end stop trigger clockwise to lower the bottom of the screw closer to the Z axis end stop.

4.1. BED LEVELING

Once lowered by approximately 1cm, press the **Home Z button** to home the Z axis. The hot end will approach the heated bed and should stop around a centimeter above the surface of the heated bed. While the Z axis is moving down pay attention to the Z axis movement and sound. The Z axis stepper motors should be moving in unison. If you notice a grinding sound, stop, turn the printer off and before proceeding, make sure that the Z axis looks level in relation to the body of the TAZ 3D printer. Manually rotate one of the Z axis linear threaded rods by hand if needed to visually level the Z axis.

Raising the Z Axis

Use the **+Z 10 button** to move the Z axis up in 10mm increments. **Commands sent in Pronterface will stack, so multiple movement button presses can potentially be harmful and cannot be stopped without powering down the 3D printer.** Keep an eye on the nozzle for the hot end. Raise the Z axis until the hot end nozzle is approximately 40-50mm away from the print bed.

Verify Z Axis Leveling

With the Z axis above the bed, use the included **150mm ruler** to measure the distance from the bottom of the **X axis** smooth rod and the top surface of the **Y axis** aluminum bed plate on the left side (Fig. 4.2, page 50).

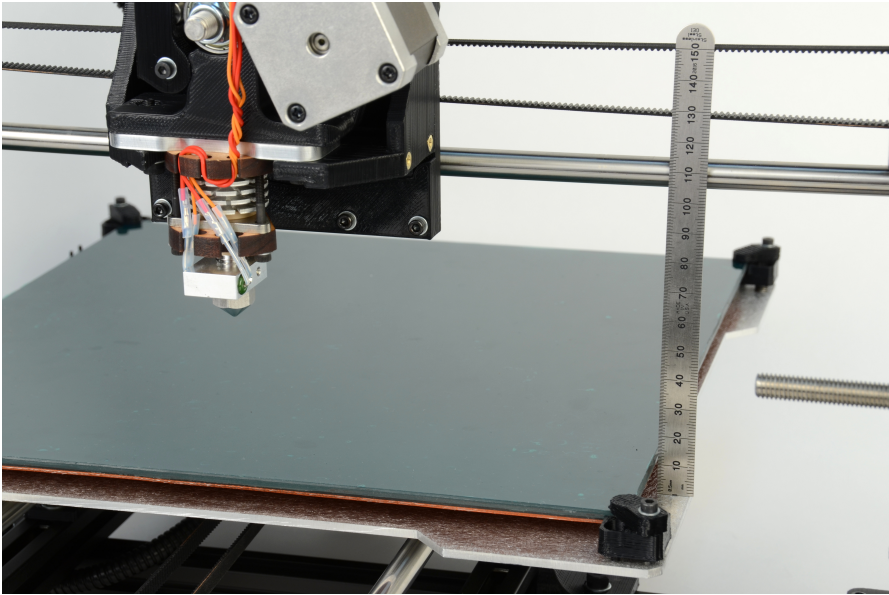

Figure 4.2: Verifying the X and Y axis are square

Compare the distance measurement from the left side to the measurement on the right side. The distance measurement should be the same. If not, in Pronterface use the **Motors off** button to turn off the stepper motors on the TAZ 3D printer. Manually, by hand, turn the threaded rod on one side of the printer to raise or lower that side to match the measurement on the other side. If the Z axis has been adjusted measure again to confirm that the left and right side of the Z axis are level in relation to the Y axis aluminum plate.

Fine Adjustment of the Z Axis End Stop

Now that the Z axis is checked for level a finer adjustment of the Z axis end stop trigger can be set. Adjust the **Z axis end stop trigger** by rotating the screw counter-clockwise to raise the tip of the screw. Raise the screw by roughly the same amount of the distance between the nozzle tip and the print surface. Press the **Home Z** button to home the Z axis. The tip of the nozzle should now be very close to the surface of the bed.

Leveling the Print Bed

Slide a thin piece of paper underneath the nozzle in the front left corner of the bed. Adjust the Z axis end stop and home the Z axis until the tip of the nozzle applies a firm pressure on the paper. Try to slide the paper from underneath the tip of the nozzle. It should not tear, but some resistance should be felt.

Move the hot end nozzle tip over to the far side of the X axis by using the **+X 100 button**. As the X axis carriage approaches the end of the X axis use the **+X 10 button** and finally the **+X 1 button**. Once the tip of the nozzle is near the front right corner of the bed slide the same piece of paper under the nozzle and home the Z axis. To raise or lower the front right corner of the bed adjust the third screw from the left. Do not adjust the middle screw. Adjust the front right corner of the bed until the amount of tension felt when moving the piece of paper under the nozzle feels the same as the tension felt when doing the same thing on the front left corner.

Repeat the same process using the **+Y button** to move the heated bed to place the nozzle on the rear right corner of the bed. Adjust the height of the bed using the same procedure as outlined above. Finally, move the X axis carriage over to the rear left corner of the bed and perform the same leveling procedure to adjust the last corner.

The bed should now be almost perfectly level. We will check this in a later section. Use the controls in Printron to raise the Z axis up 20mm, and move the X axis carriage over to the center of the X axis.

4.2 Set Temperature

Set the hot end and print surface for ABS or PLA plastic and turn both on. The temperature settings for ABS should be set at 230°C for the hot end and 85°C for print surface; for PLA they should be set at 185°C for the hot end and 55°C for print surface. These temperatures work well for filament sourced from LulzBot, however you may need to adjust the temperature a degree or two depending on the filament source, color and type. Click the **Motors Off** button.

4.3 Load Filament

Once the hot end is heated to the correct temperature you will now need to load the plastic filament into the extruder. Gently squeeze both the idler

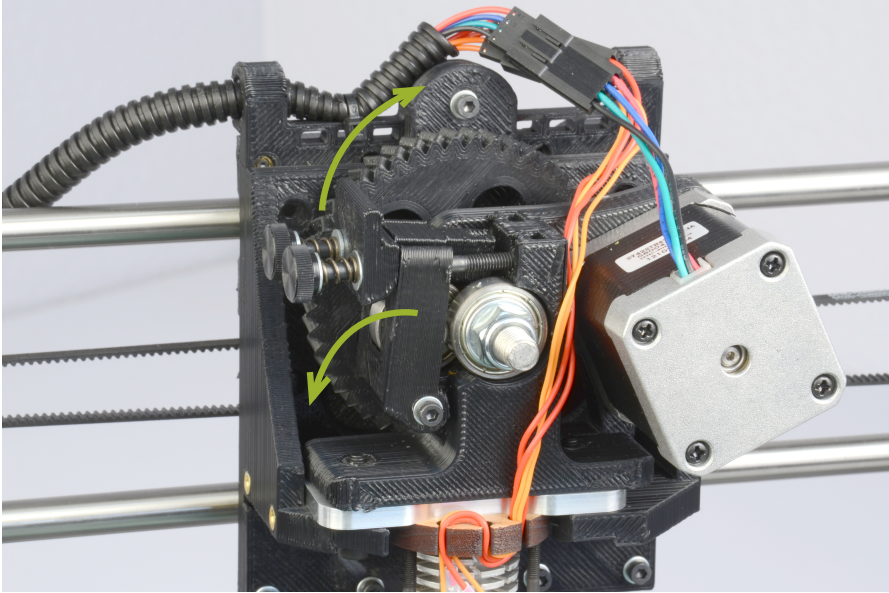

Figure 4.3: Extruder idler release

screws and the plastic clip together and pull upwards to release the idler (Fig. 4.3, page 52). The idler screws can be loosened if necessary. The idler can be rotated downwards allowing access to the hobbed bolt and filament feed hole (Fig. 4.4, page 53). If the extruder has a small section of filament already loaded, you will need to remove the filament once the extruder idler has been opened, by gently pulling out the filament by hand once the hot end has reached extrusion temperature. From the previously installed filament reel, feed the end of the plastic filament into the filament feed hole (Fig. 4.4, page 53). Now you can push the filament through the extruder by slowly pushing the filament down into the hot end.

Once the filament extrudes a small amount out of the nozzle raise the idler and slide the two idler bolts and plate back into place. Tighten the two idler bolts if you previously loosened them. Tighten the two screws until they are finger tight, then tighten them slightly more, until the top of the thumbscrews are about 10mm away from the plastic clip. Now use the

4.4. HOME PRINTER

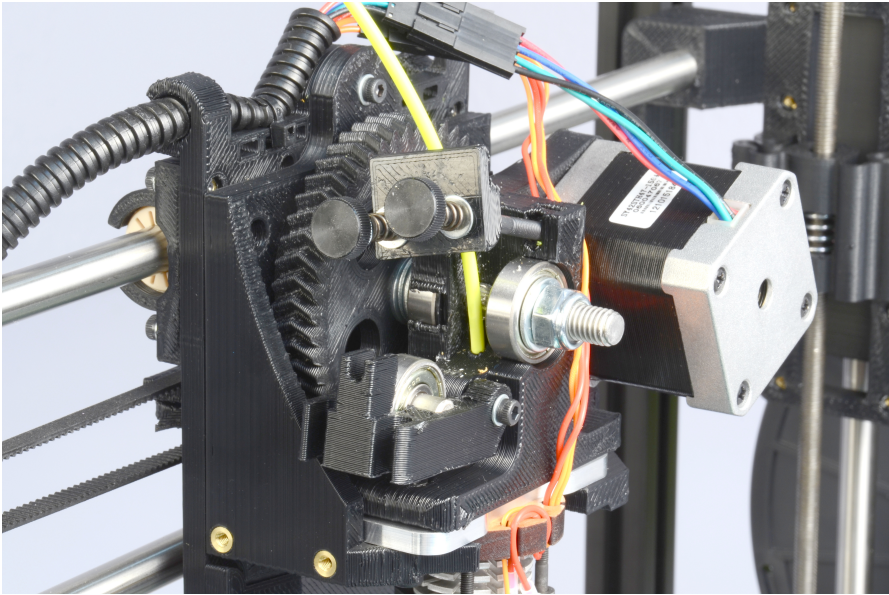

Figure 4.4: Extruder filament slot

Extrude button in Prinrun to test that the extruder is working properly. You may need to extrude 40-60mm of filament to fully prime the hot end. Adjust the tension on the two screws until you can reliably and repeatedly extrude roughly 40mm of filament.

4.4 Home Printer

Use the home buttons to home the X axis and then the Y axis. Next home the Z axis. When the Z axis is at home the nozzle tip should be right above the glass (Fig. 4.5, page 54). The image to the left, in figure 4.5, is the correct nozzle height. The nozzle should not be pushing down on the print surface. To lower or raise the Z home height adjust the Z end stop trigger. The red end stop trigger is on the far left of the printer mounted on the X-axis motor mount. (Fig. 4.6, page 54). The red end stop trigger can be lowered by turning clockwise and raised by turning counter-clockwise. Once you have homed the axes and the hot end and bed have reached the correct temperature it is time to print!

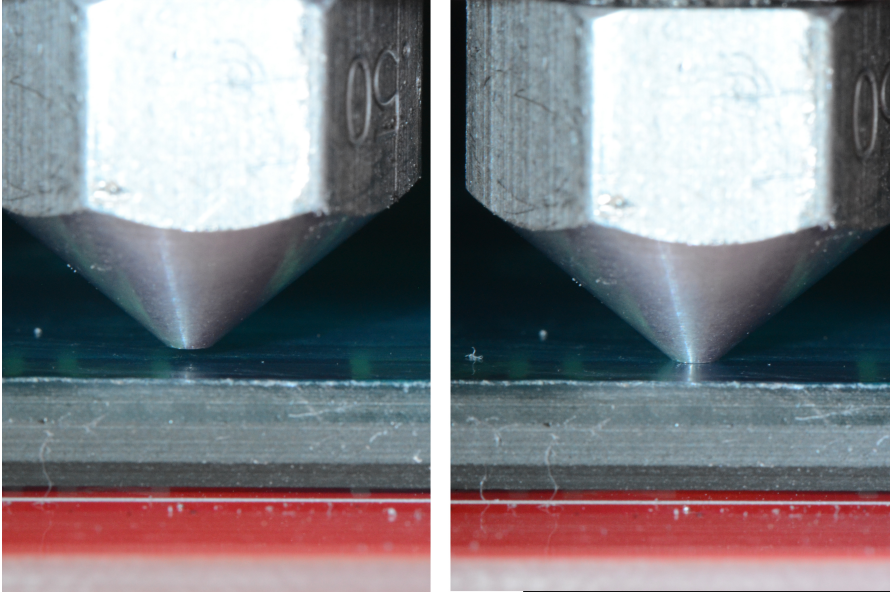

Figure 4.5: Nozzle height

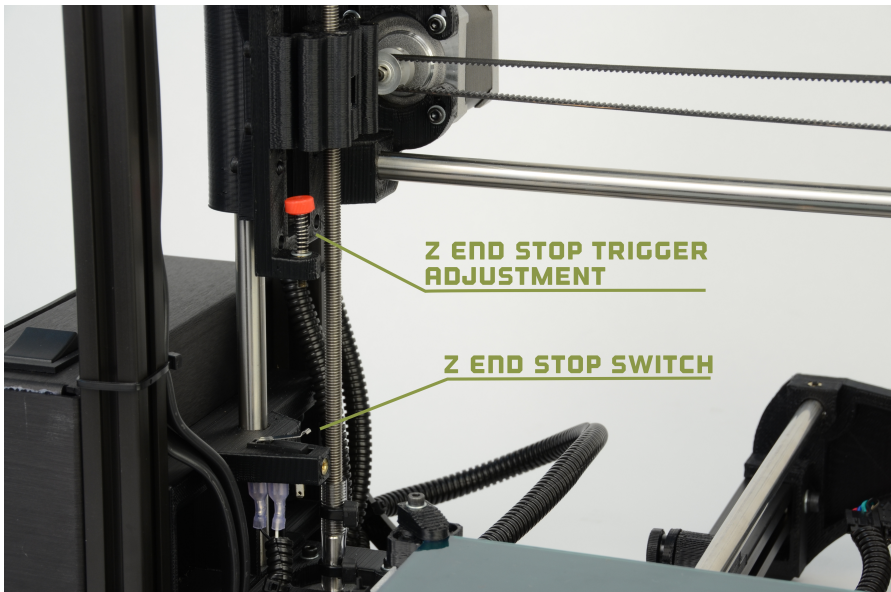

Figure 4.6: Z end stop trigger

4.5 Z Print Height

Load the `bed_level.gcode` file. This file can be found in the calibration directory on the SD card included with your TAZ 3D printer or at: <http://www.LulzBot.com/support/downloads>. Once you have downloaded the file to your computer, press the **Load file** button in Printron. Navigate through the file browser to the downloaded `bed_level.gcode` file, highlight the file and select the **Open** button.

The `.gcode` file should appear in the Printron G-Code viewer. Press the **Print** button to begin the print. When the print starts make sure the first layer is not printing too close or too far from the print bed. Note Figure 4.7, page 55, as an example of a good first layer adhesion. From left to right:

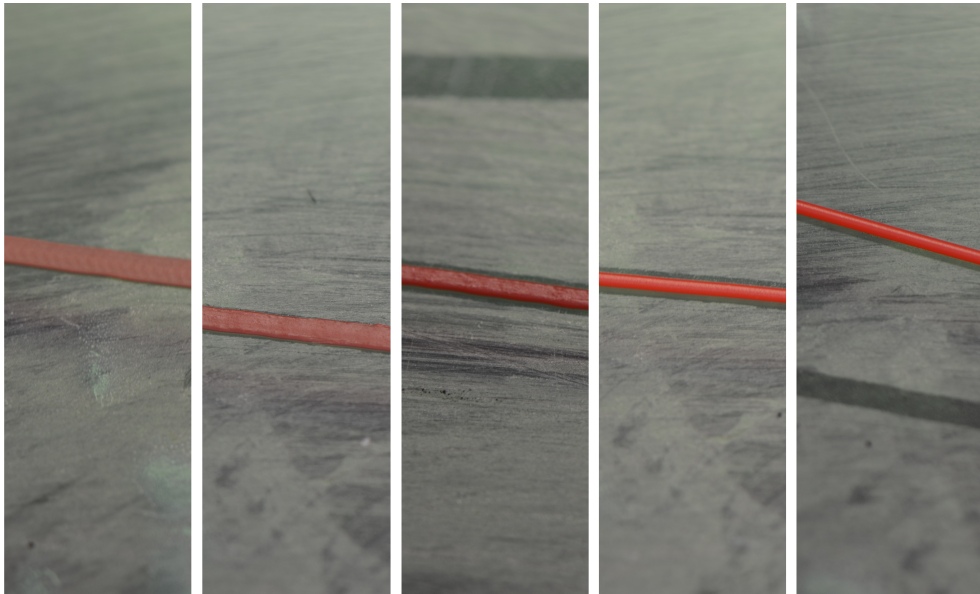

Figure 4.7: First layer adhesion

very low, low, *perfect*, high, very high. If the first layer is too high or low you can pause the print by pressing the **Pause** button. Adjust the Z end stop trigger. After making adjustments remove any printed material off the bed and home the axes and press **Restart** to restart the print. Measure the extrusion width, ideally the width would be the same in all areas of the bed. You would raise/lower a corner to minimize/increase the extrusion width to match the others. Once they are all consistent, the bed is level.

4.6 Your First Octopus!

Load the `octopus.gcode` file. This file can be found at: <http://download.lulzbot.com/TAZ/2.0/samples/>. Load the file in Pronterface, bring the hot end (230C ABS/185C PLA) and the heated bed (85C ABS/60C PLA) up to printing temperature. Once the printer is at the appropriate temperature, press the **Print** button to begin the print.

4.7 Remove Part

After the part is finished printing, the heated bed will automatically cool down to 0°C. If you are printing PLA you will need to turn the heated bed off. Once the bed cools you can pop the finished part off of the printed surface. To remove the printed part, use the clam knife included in your printer kit. Leather gloves are suggested to protect your hands from the clam knife blade. It is also safe practice to not place your hand in the direction you are pushing the clam knife. Using the side of the clam knife blade pry up one side of the printed part. If your part is large you may need to pry at multiple points to pop the part off of the print surface. When removing parts take caution to not damage the PET film. If the film is cut or ripped it will peel from the glass and need to be replaced. Make sure to reset the heated bed to the correct temperature and allow it to heat up to the needed temperature before starting the next print.

Slic3r

5.1 Introduction

Overview

Slic3r is a tool which translates digital 3D models into instructions that are understood by a 3D printer. It slices the model into horizontal layers and generates suitable paths to fill them.

Slic3r is already bundled with the many of the most well-known host software packages: Pronterface, Repetier-Host, ReplicatorG, and can be used as a standalone program.

This manual will provide guidance on how to install, configure and utilize Slic3r in order to produce excellent prints.

This portion of the manual is derived from the complete Slic3r manual. It has been customized for TAZ users. The original unabridged version can be found at manual.slic3r.org.

Goals & Philosophy

Slic3r is an original project started in 2011 by Alessandro Ranellucci (aka. Sound), who used his considerable knowledge of the Perl language to create a fast and easy to use application. Readability and maintainability of the code are among the design goals.

The program is under constant refinement, from Alessandro and the other contributors to the project, with new features and bug fixes being released on a regular basis.

Donating

Slic3r started as a one-man job, developed solely by Alessandro in his spare time, and as a freelance developer this has a direct cost for him. By generously releasing Slic3r to the public as open source software, under the GPL license, he has enabled many to benefit from his work.

The opportunity to say thank you via a donation exists. More details can be found at: <http://slic3r.org/donations>.

5.2 Getting Slic3r

Slic3r is Free Software, and is licensed under the GNU Affero General Public License, version 3.

Downloading

From LulzBot

The Slic3r version that has been tested for the TAZ printer can be downloaded from the LulzBot.com downloads page: <https://www.lulzbot.com/support/downloads>.

Pre-compiled packages are available for Windows, Mac OS X and Linux. Windows and Linux users can choose between 32 and 64 bit versions to match their system.

Slic3r

Slic3r can be downloaded directly from: <http://slic3r.org/download>.

Pre-compiled packages are available for Windows, Mac OS X and Linux. Windows and Linux users can choose between 32 and 64 bit versions to match their system.

Manual

The latest version of full Slic3r manual, with L^AT_EX source code, can be found at: <https://github.com/alexrj/Slic3r-Manual>

Source

The source code is available via GitHub: <https://github.com/alexrj/Slic3r>. For more details on building from source see §5.2 below.

Installing

Linux

Extract the archive to a folder of your choosing. Either:

- Start Slic3r directly by running the Slic3r executable, found in the bin directory, or
- Install Slic3r by running the do-install executable, also found in the bin folder.

The archive file may then be deleted.

Windows

Unzip the downloaded zip file to a folder of your choosing, there is no installer script. The resulting folder contains two executables:

- `slic3r.exe` - starts the GUI version.
- `slic3r-console.exe` - can be used from the command line.

The zip file may then be deleted.

Mac OS X

Double-click the downloaded dmg file, an instance of Finder should open together with an icon of the Slic3r program. Navigate to the Applications directory and drag and drop the Slic3r icon into it. The dmg file may then be deleted.

Building from source

For those wishing to live on the cutting edge, Slic3r can be compiled from the latest source files found on GitHub <https://github.com/alexrj/Slic3r>.

Up-to-date instructions for compiling and running from source can be found on the Slic3r wiki.

5.3 First Print

Calibration

Before even attempting the first print it is vital that the printer is correctly calibrated. Skipping or rushing this step will result in frustration and failed prints later, so it is important to take the time to make sure the machine is

5.3. FIRST PRINT

correctly set up. Be sure to complete the Setup and First Print section of this manual before moving forward with Slic3r.

If you are just beginning with 3D printing or Slic3r, LulzBot recommends starting with our pre-set Slic3r profiles. You can find the TAZ Slic3r profiles at <https://www.lulzbot.com/support/downloads>. For information on loading and export Slic3r profiles please see page 114. Note that the pre-set profiles will only work correctly when Slic3r is in Expert mode.

The pre-set profiles will give you Slic3r settings that will work great on most designs. The Slic3r manual can be used as a reference in building knowledge of Slic3r settings while using the pre-set profiles. Once you have a number of prints completed you can use the Slic3r manual as a reference to make small adjustments to the pre-set profiles or begin creating your own profiles.

Configuration Wizard

Slic3r has two features to aid newcomers: the configuration wizard, and simple mode.

Sometimes it is nice to have a helping hand when starting out with new software. The configuration wizard asks a series of questions and creates a configuration for Slic3r to start with.

When using the pre-set TAZ Slic3r profiles you do not need to complete the Configuration Wizard. The Configuration Wizard can be later accessed from the top menu once you are ready to start creating your own Slic3r profiles.



Figure 5.1: Configuration Wizard: Welcome Screen

5.3. FIRST PRINT

1. Firmware Type

The gcode produced by Slic3r is tailored to particular types of firmware. The first step prompts for the firmware that the printer uses. For the TAZ printer select RepRap (Marlin/Sprinter)

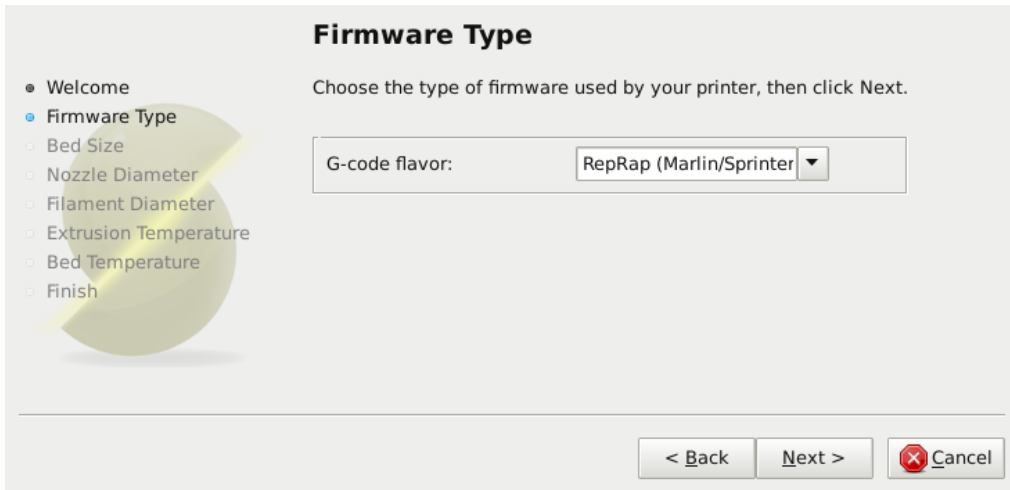

Figure 5.2: Configuration Wizard: Firmware Type

2. Bed Size

This setting defines the maximum distance the extruder may travel along the X and Y axis. The dimension for the TAZ print surface are X: 298 and Y: 280.

Be sure to measure from the lower left corner where the extruder nozzle rests when are the home position to the maximum distance the nozzle can travel in each direction. Take into account that the X carriage may touch the frame before the nozzle reaches it's full distance, this will depend on the printer make and model.

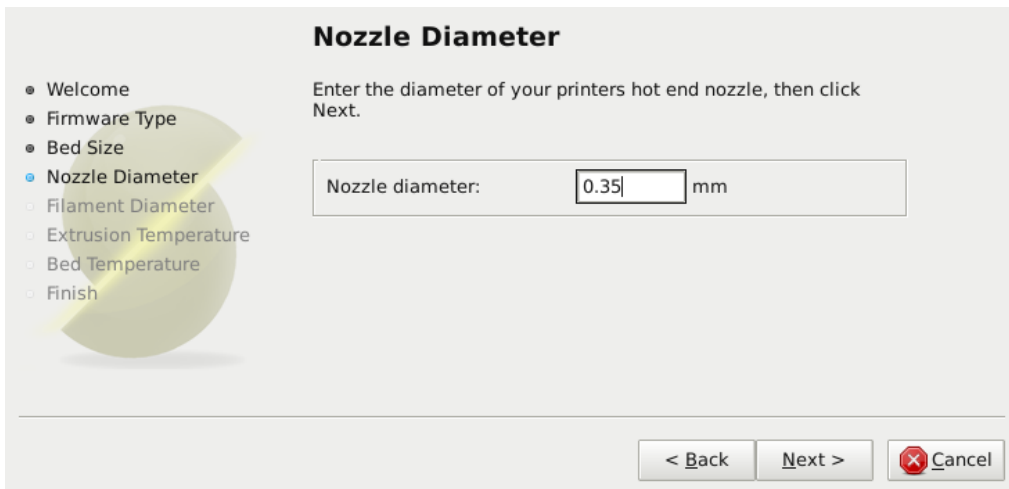

Figure 5.3: Configuration Wizard: Bed Size

3. Nozzle Diameter

The diameter of the hot-end nozzle is usually clearly displayed either in the description of the hot-end, or in the associated documentation, when the hot-end is purchased. The default nozzle size on the TAZ hot end is 0.35mm.

If the nozzle was home-made, or came from a source without a diameter given, then carefully measure the aperture as accurately as possible. One way of determining nozzle size is to very slowly (1mm/s) extrude some filament into free air and measure the thickness of the resulting extrusion¹. This has the benefit of taking die swell into account, and consequently may be a useful thing to do even if the diameter is known.



Nozzle Diameter

- Welcome
- Firmware Type
- Bed Size
- **Nozzle Diameter**
- Filament Diameter
- Extrusion Temperature
- Bed Temperature
- Finish

Enter the diameter of your printers hot end nozzle, then click Next.

Nozzle diameter: mm

< Back Next > 

Figure 5.4: Configuration Wizard: Nozzle Diameter

¹ <http://forums.reprap.org/read.php?1,113374,113953>

4. Filament Diameter

For Slic3r to produce accurate results it must know as accurately as possible how much material is pushed through the extruder. Therefore it is vital to give it as precise a value as possible for the filament diameter.

Although the filament used in FDM printers is sold as being either 3mm or 1.75mm this is only a general guide. The diameter can vary between manufacturers and even between batches. Therefore it is highly recommended to take multiple measurements from along a length of the filament and use the average. For example, measurements of 2.89, 2.88, 2.90 and 2.91 would yield an average of 2.895, and so this would be used.

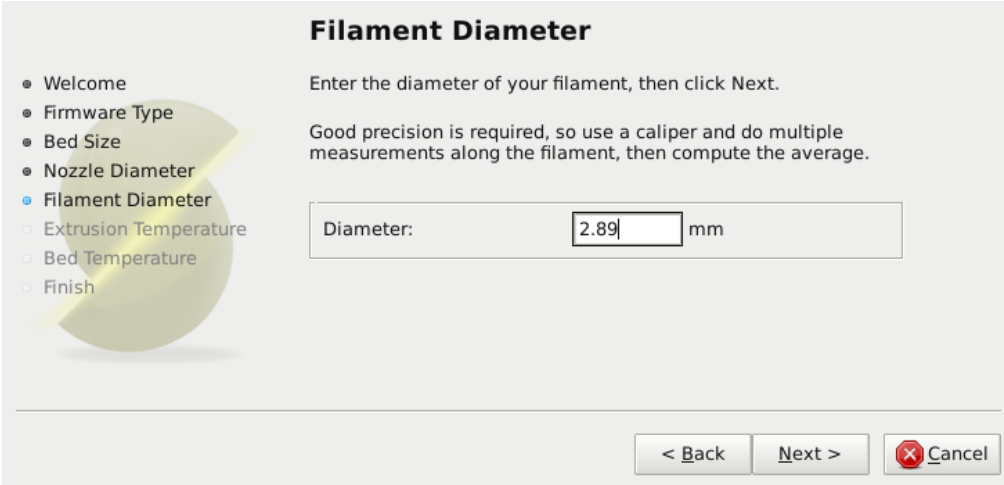

The screenshot shows the 'Filament Diameter' step of the Slic3r Configuration Wizard. On the left, a vertical list of steps is shown with radio buttons: 'Welcome', 'Firmware Type', 'Bed Size', 'Nozzle Diameter', 'Filament Diameter' (selected with a blue dot), 'Extrusion Temperature', 'Bed Temperature', and 'Finish'. The main area is titled 'Filament Diameter' and contains the following text: 'Enter the diameter of your filament, then click Next.' and 'Good precision is required, so use a caliper and do multiple measurements along the filament, then compute the average.' Below this text is a text input field labeled 'Diameter:' containing the value '2.89' followed by 'mm'. At the bottom right, there are three buttons: '< Back', 'Next >', and a red 'X' button labeled 'Cancel'.

Figure 5.5: Configuration Wizard: Filament Diameter

5. Extrusion Temperature

The extrusion temperature will depend on the material, and most can operate over a range of temperatures. The supplier should provide guidance as to which temperatures are suitable. A very general rule of thumb is that PLA lies between 160°C and 230°C, and ABS lies between 220°C and 240°C. More exotic materials will have a different range.

This is one parameter which you will want to fine tune when you start producing prints. The optimal temperature can vary even between colors of the same material. Another factor which may affect the chosen temperature is how fast the extrusion is, where generally faster extrusion runs hotter.

Note: One may choose to control the extruder temperature manually from the printer controller. In this case the temperature can be set to zero.

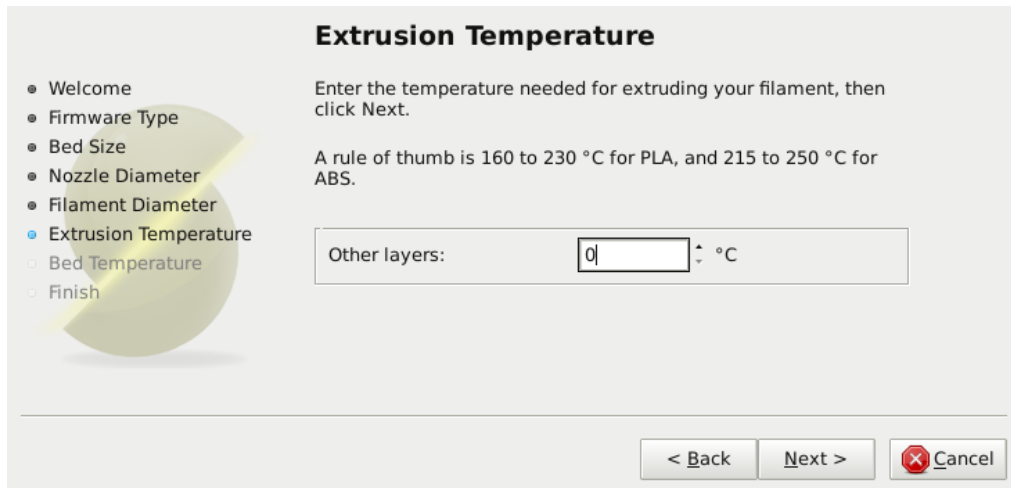

Extrusion Temperature

- Welcome
- Firmware Type
- Bed Size
- Nozzle Diameter
- Filament Diameter
- **Extrusion Temperature**
- Bed Temperature
- Finish

Enter the temperature needed for extruding your filament, then click Next.

A rule of thumb is 160 to 230 °C for PLA, and 215 to 250 °C for ABS.

Other layers: °C

< Back Next >  Cancel

Figure 5.6: Configuration Wizard: Extrusion Temperature

6. Bed Temperature

If the printer has a heated bed then this parameter may be set. As with the extruder temperature, the value will depend on the material used. A rule of thumb is that PLA requires 35°C - 60°C and ABS requires 85°C.

Note: One may choose to control the bed temperature manually from the printer controller. In this case the temperature can be set to zero.

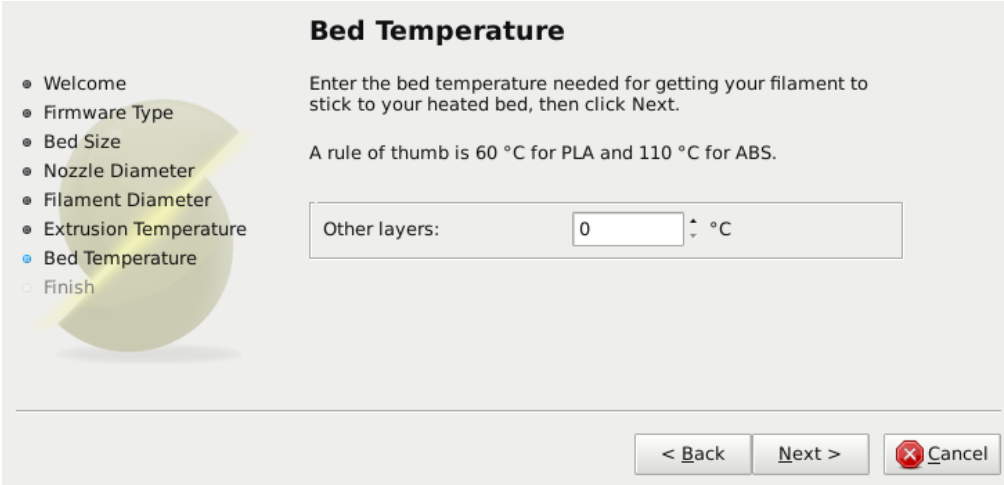

The screenshot shows the 'Bed Temperature' configuration screen in the Slic3r Configuration Wizard. On the left, a vertical list of steps is shown: Welcome, Firmware Type, Bed Size, Nozzle Diameter, Filament Diameter, Extrusion Temperature, Bed Temperature (highlighted with a blue dot), and Finish. The main area contains the title 'Bed Temperature', instructions to enter the bed temperature, and a rule of thumb for PLA and ABS. A text input field labeled 'Other layers:' contains the value '0' followed by a degree Celsius symbol. At the bottom, there are three buttons: '< Back', 'Next >', and a red 'X' icon labeled 'Cancel'.

Figure 5.7: Configuration Wizard: Bed Temperature

5.3. FIRST PRINT

At this stage the wizard is complete and the basic configuration is defined.

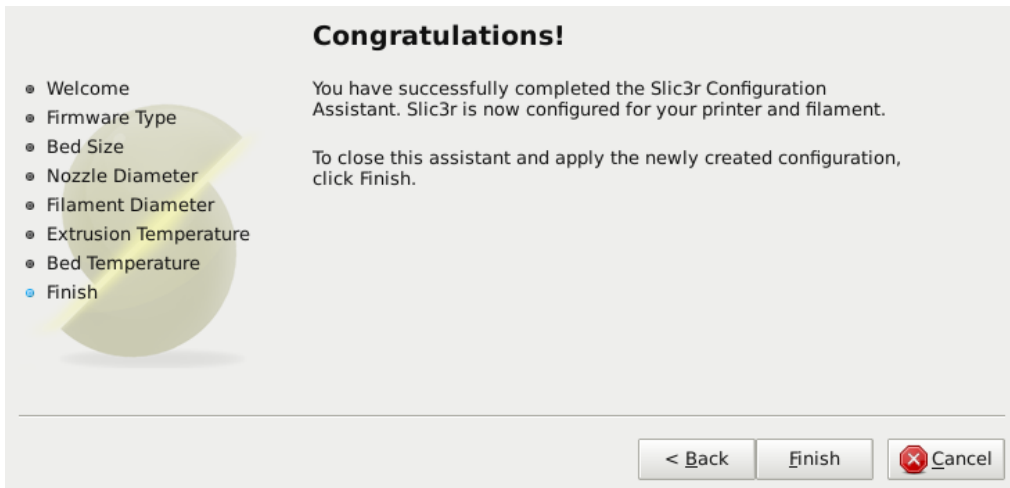

Figure 5.8: Configuration Wizard: End

The Important First Layer

Before delving into producing the first print it is worthwhile taking a little detour to talk about the importance of getting the first layer right. As many have found through trial and error, if the first layer is not the best it can be then it can lead to complete failure, parts detaching, and warping. There are several techniques and recommendations one can heed in order to minimise the chance of this happening.

Level bed. Having a level bed is critical. If the distance between the nozzle tip and the bed deviates by even a small amount it can result in either the material not lying down on the bed (because the nozzle is too close and scrapes the bed instead), or the material lying too high from the bed and not adhering correctly.

Higher temperature. The extruder hot-end and bed, if it is heated, can be made hotter for the first layer, thus decreasing the viscosity of the material being printed. As a rule of thumb, an additional 5° is recommended.

Lower speeds. Slowing down the extruder for the first layer reduces the forces applied to the molten material as it emerges, reducing the chances of it being stretched too much and not adhering correctly. 30% or 50% of the normal speed is recommended.

Correctly calibrated extrusion rates. If too much material is laid down then the nozzle may drag through it on the second pass, causing it to lift off the bed (particularly if the material has cooled). Too little material may result in the first layer coming loose later in the print, leading either to detached objects or warping. For these reasons it is important to have a well-calibrated extrusion rate as recommended in §5.3).

First layer height. A thicker layer height will provide more flow, and consequently more heat, making the extrusion adhere to the bed more. It also gives the benefit of giving more tolerance for the levelness of the bed. It is recommended to raise the first layer height to match the diameter of the nozzle, e.g. a first layer height of 0.35mm for a 0.35mm nozzle. Note: The first layer height is set this way automatically in simple mode.

5.3. FIRST PRINT

Fatter extrusion width. The more material touching the bed, the better the object will adhere to it, and this can be achieved by increasing the extrusion width of the first layer, either by a percentage or a fixed amount. Any spaces between the extrusions are adjusted accordingly.

A value of approximately 200% is usually recommended, but note that the value is calculated from the layer height and so the value should only be set if the layer height is the highest possible. For example, if the layer height is 0.1mm, and the extrusion width is set to 200%, then the actual extruded width will only be 0.2mm, which is smaller than the nozzle. This would cause poor flow and lead to a failed print. It is therefore highly recommended to combine the high first layer height technique recommended above with this one. Setting the first layer height to 0.35mm and the first extrusion width to 200% would result in a nice fat extrusion 0.65mm wide.

Bed material. Many options exist for the material to use for the bed, and preparing the right surface can vastly improve first layer adhesion.

PLA is more forgiving and works well on PET, Kapton, or blue painters tape.

ABS usually needs more cajoling and, whilst it can print well on PET and Kapton, there are reports that people have success by applying hairspray to the bed before printing. Others have reported that an ABS slurry (made from dissolving some ABS in Acetone) thinly applied can also help keep the print attached.

No cooling. Directly related with the above, it makes no sense to increase the temperature of the first layer and still have a fan or other cooling mechanism at work. Keeping the fan turned off for the first few layers is generally recommended.

Working with Models

Yet another step lies between now and the first print - a model has to be found and then sliced.

Model Formats

Slic3r accepts the following file types.

- STereoLithography (STL) files can come from a wide variety of sources and are now a de facto standard in 3D printing. The files simply describe the surface geometry of a 3D object without any additional information (such as color or material), and it is this simplicity that has probably made the format ubiquitous.
- Wavefront OBJ files are an open format originally used in an animation application from Wavefront Technologies, but has since been adopted by the wider 3D modelling community. It is similar to the STL format.
- Additive Manufacturing File Format (AMF) was developed in response to the limited nature of the STL format. In addition to describing the geometry of the 3D model it can also describe colors and materials, as well as more complex attributes, such as gradient mixes and multiple object arrangements (constellations). Whilst the format is deemed a standard it has yet to be widely adopted in the 3D maker community.

Finding Models

The 3D model files may come from an online repository, such as Thingiverse² or GrabCAD³, or be created from a CAD program, such as FreeCAD⁴, Sketchup⁵, or OpenSCAD⁶, or an online CAD tool such as Shapsmith⁷.

You may wish to view the files before slicing and there are many free applications available, one of which is Meshlab⁸ - a comprehensive tool for viewing and working with 3D files.

²<http://www.thingiverse.com>

³<http://grabcad.com>

⁴<http://sourceforge.net/projects/free-cad>

⁵<http://www.sketchup.com>

⁶<http://www.openscad.org>

⁷<http://shapsmith.net>

⁸<http://www.meshlab.org>

5.3. FIRST PRINT

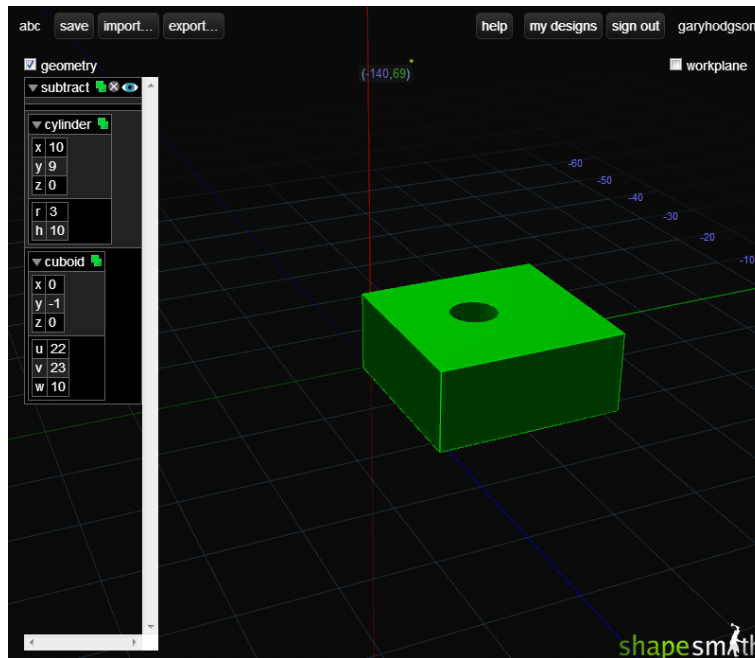

Figure 5.9: Shapeways online CAD tool.

Working with Plater

Slic3r has a tool, called Plater, which allows one or more models to be loaded and arranged before being sliced.

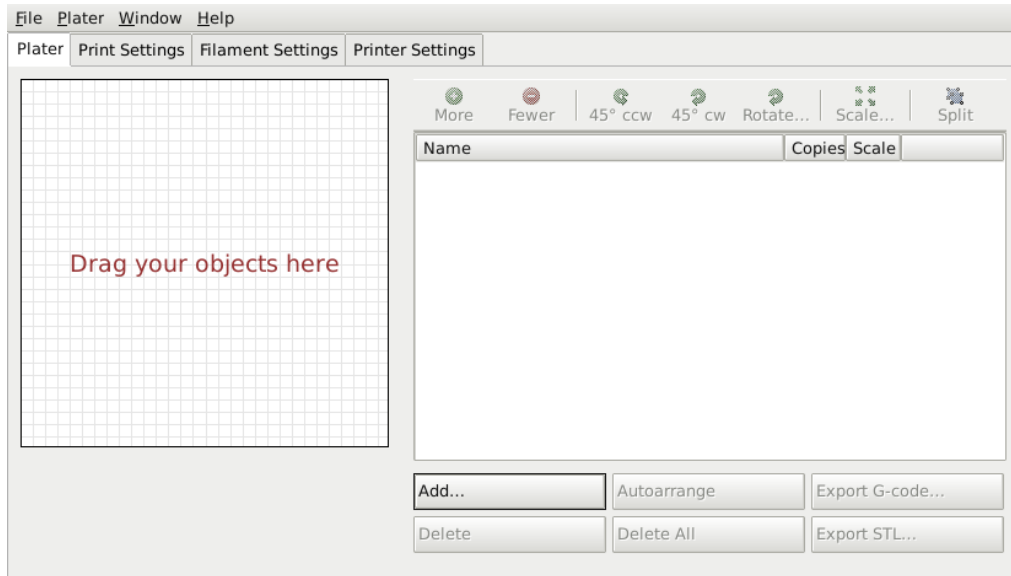

Figure 5.10: Plater

Once you have acquired a model, drag it onto the Plater window (or use the Add button below the file list) to load it into Slic3r. In the figure below, the traditional RepRap Minimug⁹ is loaded, and is viewed from above. The ring around the model is a skirt - a single perimeter, several millimeters away from the model, which is extruded first. This is useful in making sure the plastic is flowing smoothly from the nozzle when the model is starting to be printed.

⁹<http://www.thingiverse.com/thing:18357>

5.3. FIRST PRINT

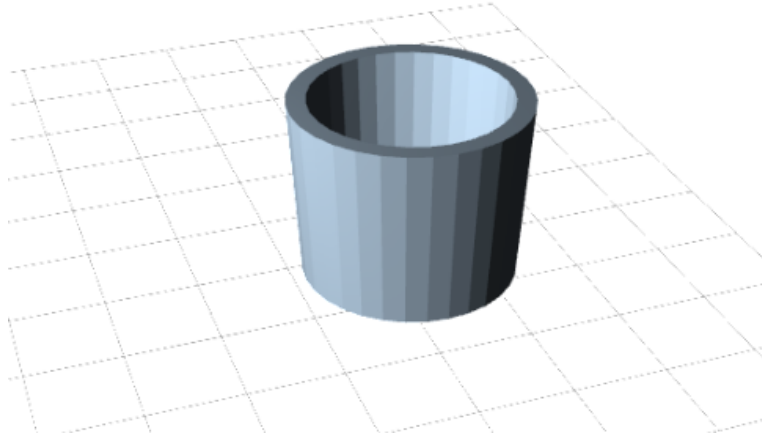

Figure 5.11: Minimug model.

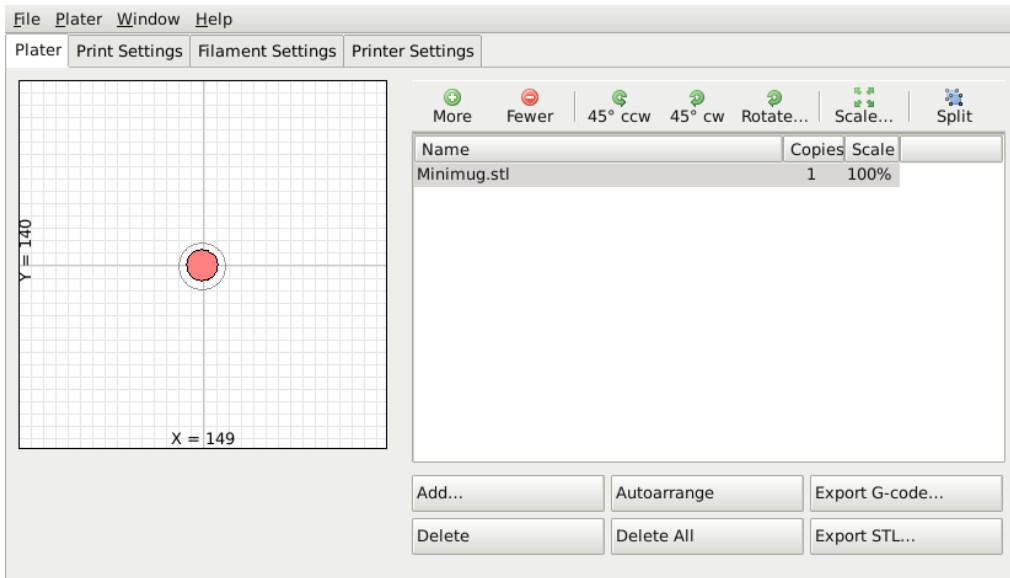

Figure 5.12: STL file loaded.

The model can be repositioned by dragging the representation of it on the left of the screen around the bed. Note that the dimensions of the bed should match your printer, as given during the initial configuration above.

On the right-hand side is the list of currently loaded files. The buttons along the top of the file list allow you to arrange the models.

- **More/Less** - Adjust how many copies should be printed.
- **45°/Rotate** - Rotate the selected model around the Z axis, either in 45° increments clockwise or counter-clockwise, or by a given amount.
- **Scale** - Increase or decrease the size of the printed model.
- **Split** - Divides a model which consists of more than one part into its constituent parts, allowing each one to be arranged individually.

The buttons along the bottom of the file list allow you to add, remove, auto-arrange, or export the models.

- **Add** - Opens a file dialog to add a model to the plater, as an alternative to dropping a file directly.
- **Delete/Delete All** - Remove one or all models from the plater.
- **Autoarrange** - Attempt to arrange the models to give the optimal layout.
- **Export G-code** - Starts slicing the model and produces a G-Code file.
- **Export STL** - Save the current set of models as a single STL file.

Cleaning STLs

If the 3D mesh described in the model contains holes, or edges are misaligned (known as being non-manifold), then Slic3r may have problems working on it. Slic3r will attempt to fix any problems it can, but some problems are out of its reach. If the application complains that a model cannot be sliced correctly then there are several options available: see the chapter about Repairing Models.

Printing

At this stage Slic3r has been configured and a model has been acquired, sliced and made ready for print. Now would be the time to fire up the printer and try it out.

A variety of host software is available to send the G-code to the printer. Amongst the open-source solutions are: Printron¹⁰, Repetier¹¹ and Reprap¹².

The following subsections will cover the options available in expert mode, and look at advanced printing techniques, including special cases and troubleshooting.

5.4 Simple Mode

Simple Mode

Slic3r has two modes of operation, Simple and Expert. These may be chosen from the **Preferences** window (found under the **File** menu).

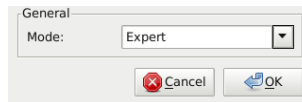

Figure 5.13: Preferences.

Simple mode offers a reduced set of options, enough for the beginner to get started with. Expert mode gives more control over how Slic3r produces the G-code and will be looked at later.

Print Settings

The **Print Settings** tab provides the opportunity to change settings related to the actual print. Whereas the other tabs are changed rarely, the settings on this tab will be modified regularly, possibly for each model printed.

¹⁰<https://github.com/kliment/Printrun>

¹¹<http://www.repetier.com/>

¹²<https://github.com/timschmidt/repsnapper>

File Plater Window Help

Plater Print Settings Filament Settings Printer Settings

General

Layer height: 0.3 mm

Perimeters (minimum): 2

Solid layers: Top: 3 Bottom: 3

Infill

Fill density: 0.3

Fill pattern: rectilinear

Support material

Generate support material:

Pattern spacing: 2.5 mm

Raft layers: 0 layers

Speed

Perimeters: 30 mm/s

Infill: 60 mm/s

Travel: 130 mm/s

Brim

Brim width: 0 mm

Sequential printing

Complete individual objects:

Extruder clearance (mm): Radius: 20 Height: 20

Want more options? Switch to the Expert Mode.

Figure 5.14: Simple Mode: Print Settings.

General. **Layer height** is the thickness of each layer, and it is the step along the vertical axis taken before extruding a new layer atop the previous one. There are several factors that influence how high each layer should be:

- **Desired resolution** - Lower layer height should result in prints with less noticeable ribs or bands, as each layer is smaller. Aesthetics plays a role here, but also the type of model, for example, a mechanical part may not need such a high resolution finish, whereas a presentation piece may do so.

5.4. SIMPLE MODE

- **Print speed** - Shorter layers will result in smoother prints but each print will take longer, simply because the extruder must trace the pattern more times. A later goal will be to strike a balance between layer height, the speed of the printer, and the quality of the resulting print.

Perimeters defines the minimum number of vertical shells (i.e. walls) a print will have. Unless the model requires single width walls it is generally recommended to have a minimum of two perimeters as this gives some insurance that if a subsection of the perimeter is not printed correctly then the second perimeter will help cover it.

The upper and lowermost layers that sandwich the model are filled with a **Solid layers** pattern. For the bottom layers the important factor to consider is how the surface will look should there be a mistake whilst laying down the first layer, and for this reason it is recommended to have at least two bottom layers.

A similar consideration is required for the top layers. Because the intermediate layers are likely to be filled with a pattern set less than 100% then the covering layers will have to bridge this pattern and this can require more than one pass to cover completely.



Figure 5.15: An example of insufficient top layers.

Another tip to consider: Setting the top solid layer to zero, and setting the infill also to zero, will result in a hollow receptacle, ideal for turning models into vases¹³ for example. Here manipulating the settings within Slic3r can be used to generate different kinds of prints, and not only be used to control surface accuracy.

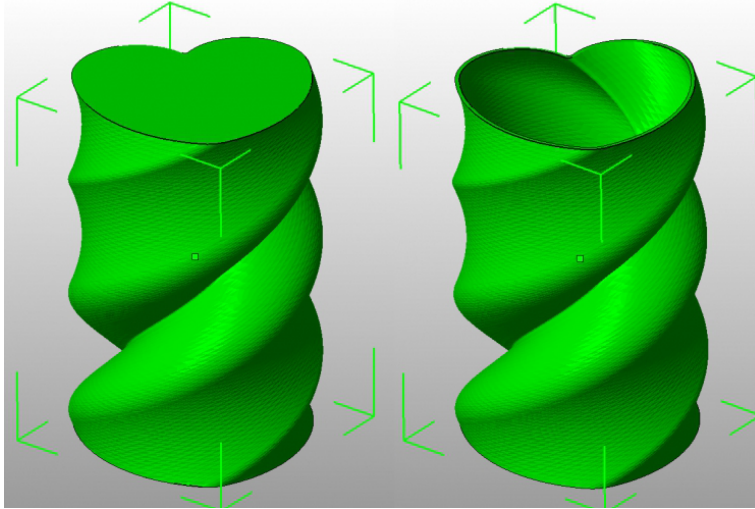

Figure 5.16: Creating a vase from a solid model.

Infill. Fill density is defined on a scale of between 0 and 1, where 1 is 100% and 0.4 would be 40%. For the majority of cases it makes no sense to 100% fill the model with plastic, this would be a waste of material and take a long time. Instead, most models can be filled with less material which is then sandwiched between layers filled at 100% (see **Solid layers** above).

A density value of 0.4 is enough to give almost all models good mechanical strength. A value of 0.2 is usually the minimum required to support flat ceilings.

Slic3r offers several fill patterns which will be discussed in more depth in subsection 5.5 - Infill Choices. Choosing a **Fill pattern** will depend on the kind of model, the desired structural strength, print speed, and personal taste. The more exotic fill methods are usually too slow and unnecessarily complex for most use cases, and so most of the time the infill pattern is either

¹³<http://slic3r.org/blog/tip-printing-vases>

5.4. SIMPLE MODE

rectilinear, line, or honeycomb. Honeycomb gives the most strength but is slower than both rectilinear or line.

Support material. Printing a model from the bottom up, as with FDM, means that any significant overhangs will be printed in the air, and most likely droop or not print correctly. Choosing support material (**Generate support material**) will add additional structures around the model which will build up to then support the overhanging part. The **Pattern spacing** option determines how dense the support material is printed.

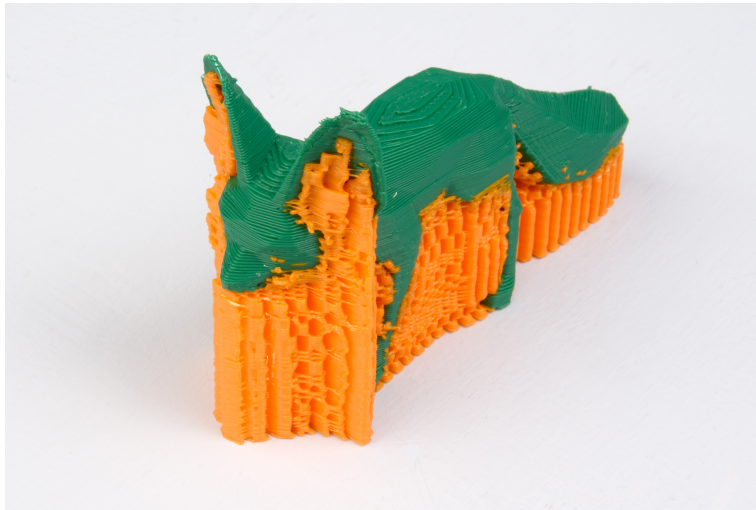

Figure 5.17: An example of an object printed with support material.

Tip: It is sometimes worth considering altering the orientation of the model in order to possibly reduce overhangs.

Raft layers will add additional layers underneath the model and stems from the early days of 3D printing. It can help with prints without a heated bed, or where the bed is not very flat, but it is usually not required and is not recommended. The raft also requires post-processing to remove it.

Speed. In simple mode there are only three speed settings to consider:

- **Perimeters** - The outline of the model may benefit from being printed slightly slower so that the outside skin of the print has fewer blemishes.

- **Infill** - As the infill is hidden this can be extruded a little faster. Take care though not to go too fast as higher speeds results in thinner extrusions, and this may affect how the extrusions bond.
- **Travel** - The jump between the end of one extrusion and the next should usually be performed as quickly as the printer will allow in order to minimise any mess caused by material oozing from the nozzle.

Brim. **Brim width** is used to add more perimeters to the first layer, as a base flange, in order to provide more surface area for the print to stick to the bed with in order to reduce warping (see §5.3). The brim is then cut away once the print is finished and removed from the bed.



Figure 5.18: An example of brim.

Sequential Printing. This feature allows to compose a plate of objects but have the printer complete each one individually before going back to $Z = 0$ and starting with the next one. See the subsection about Sequential Printing in the Advanced Topics chapter.

Filament Settings

The **Filament Settings** will normally be used infrequently, for example on receipt of a new roll of filament.

5.4. SIMPLE MODE

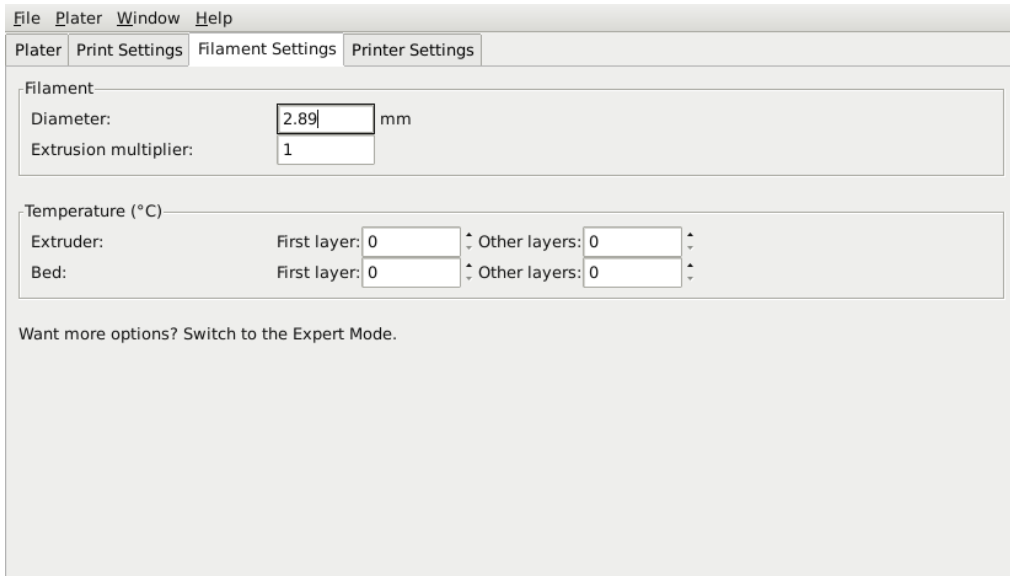

Figure 5.19: Simple Mode: Filament Settings.

Filament. The **Diameter** setting will already have been filled from the value given during the wizard (see p.66), but can be updated here.

The **Extrusion multiplier** setting allows the fine tuning of the extrusion flow rate, and is given as a factor, e.g. 1 means 100%, 1.5 would mean 150%. Whilst the value should ideally be set in the firmware it can be useful to test slight changes to the rate by altering this value. It varies the amount of plastic proportionally and should be changed in very small steps (e.g. +/- 0.05) as the effects are very visible.

Temperature. These values are also filled from the wizard, but here the opportunity exists to set the temperature for the first layer (see p.70).

Printer Settings

The **Printer Settings** will be updated the least, unless Slic3r is going to be used for many printers, for example, in a 3D printer farm.

File Plater Window Help

Plater Print Settings Filament Settings Printer Settings

Size and coordinates

Bed size: x: 298 y: 280 mm

Print center: x: 149 y: 140 mm

Z offset: 0 mm

Firmware

G-code flavor: RepRap (Marlin/Sprinter)

Extruder

Nozzle diameter: 0.35 mm

Retraction

Length: 1.6 mm (zero to disable)

Lift Z: 0 mm

Start G-code

G28 ; home all axes

End G-code

```
M400 ;
M104 S0 ; turn off nozzle temperature
M140 S0 ; turn off bed temperature
G1 Y280
G28 X0 ; home X axis
M84 ; disable motors
```

Want more options? Switch to the Expert Mode.

Figure 5.20: Simple Mode: Printer Settings.

Size and coordinates. The **Bed size** setting is taken from the wizard (see p.64) and is only used for previewing the model in the plater.

The **Print center** is the point around which the print will be centered. A **Bed size** of 200mmx200mm and a **Print center** of 100mmx100mm would sit the print in the middle. Should it be desired to print away from the center, because of a scratch in the glass perhaps, then this option should be used.

Z offset can be used to compensate for an incorrectly calibrated Z end-stop. If the nozzle stops slightly too far from the bed, then adding a

5.4. SIMPLE MODE

negative value will offset all layers by that amount. The correct solution however is to fix the end-stop itself.

The optimal Z endstop position is where the nozzle tip barely touches the surface of the bed when homed. A sheet of paper makes a good gauge for this very small distance. It is not recommended to use this setting to try and improve layer adhesion, by "squashing" the bottom layer into the bed, instead look at the suggestions in subsection 5.3.

Firmware. As selected in the wizard (see p.63), `G-code flavour` defines the dialect of G-code generated.

Extruder. `Nozzle diameter` was defined in the wizard (see p.65).

Retraction. Unless the material being extruded has a very high viscosity it may ooze between extrusions due to gravity. This can be remedied by actively retracting the filament between extrusions. Setting the `Length` parameter to a positive value will cause the filament to be reversed by that many millimeters before travel. The retraction will then be compensated for by the same amount after the travel move, before starting the new extrusion path.

A value of between 1 and 2mm is usually recommended. Bowden extruders may need up to 4 or 5mm due to the hysteresis introduced by the tube. Setting the `Lift Z` parameter to a positive value will raise the entire extruder on the Z axis by that many millimeters during each travel. This can be useful to ensure the nozzle will not catch on any already laid filament, however it is usually not necessary and will slow the print speed. A value of 0.1mm is usually sufficient.

Start, End and Layer Change G-codes. Custom G-code commands can be run before a print starts and after a print finishes.

Placeholders can be inserted in the G-code commands¹⁴. For example `[next_extruder]` would return the index of the next extruder.

The RepRap wiki is a good resource to learn about the variety of G-codes available: <http://reprap.org/wiki/G-code>.

Note: Be sure to check that a given G-code is valid for your firmware.

¹⁴<https://github.com/alexrij/Slic3r/wiki/FAQ#what-placeholders-can-i-use-in-custom-g-code>

The codes specified in **Start G-code** are inserted at the beginning of the output file, directly after the temperature control commands for extruder and bed. Note that if temperature control commands are specified (M104 and M190) then these will replace the temperature G-codes introduced by the **Filament** settings.

Some common G-codes to use before the print starts are:

- **G28** - Homes all the axes.

Some common G-codes to use after the print ends are:

- **M104 S0** - Sets the extruder temperature to zero.
- **M140 S0** - Sets the heated bed temperature to zero.
- **G28 X0** - Home the X axis.
- **M84** - Disables the motors.

5.5 Expert Mode

Speed

Once the printer is reliably producing good quality prints it may be desirable to increase the speed. Doing this provides several benefits, the most obvious of which is that the results are produced quicker, but also faster print times can be utilised in producing more layers, i.e. lower layer height, thus improving perceived print quality. An additional benefit is that a faster travel movement, between extrusions, can reduce the effects of oozing.

The best approach is to increment the various speed parameters in small steps and observe the effect each change has on print quality. Travel speed is a safe starting point, and it is not unrealistic to attain speeds of up to 250mm/s (if your printer can handle it). Adjusting the speed of perimeters, infill is available in simple mode, and the general rule is to have the perimeter go a little slower than the infill in order to reduce possible blemishes on the surface (infill can be faster because slight gaps will not matter as much).

Expert mode offers more parameters to fine tune printer speeds. Differentiation between external, small and other perimeters, infill locations, and bridges and gaps are available, as well as the ability to slow down for the first layer.

5.5. EXPERT MODE

Speed for print moves		
Perimeters:	<input type="text" value="90"/>	mm/s
Small perimeters:	<input type="text" value="40"/>	mm/s or %
External perimeters:	<input type="text" value="70"/>	mm/s or %
Infill:	<input type="text" value="100"/>	mm/s
Solid infill:	<input type="text" value="100"/>	mm/s or %
Top solid infill:	<input type="text" value="50%"/>	mm/s or %
Support material:	<input type="text" value="60"/>	mm/s
Bridges:	<input type="text" value="60"/>	mm/s
Gap fill:	<input type="text" value="40"/>	mm/s

Speed for non-print moves	
Travel:	<input type="text" value="150"/> mm/s

Modifiers	
First layer speed:	<input type="text" value="50%"/> mm/s or %

Acceleration control (advanced)		
Perimeters:	<input type="text" value="0"/>	mm/s ²
Infill:	<input type="text" value="0"/>	mm/s ²
Bridge:	<input type="text" value="0"/>	mm/s ²
Default:	<input type="text" value="0"/>	mm/s ²

Figure 5.21: Expert mode speed options.

Where indicated a value can be given in percentage. This is in relation to the preceding value, e.g. 50% solid infill would be half of the value defined for infill.

A few general guidelines for each option:

- **Perimeters** - In expert mode this parameter can be increased slightly as the **External perimeters** option can be used to ensure blemish free external faces.
- **Small perimeters** - Meant for holes, islands and fine details, a slower speed here is recommended.
- **External perimeters** - A slightly slower value may ensure cleaner surfaces.

- **Infill** - As fast as you can without compromising the integrity of the fill structure. Faster extrusions can break and result in weak spots.
- **Solid infill** - The bottom of the model, and any additional solid layers is usually slightly slower than infill but faster than perimeters.
- **Top solid infill** - Allow time for the extrusion to cleanly cover the previous top layers and result in a tidy top surface. The last few layers should have bridged the infill structure nicely, preparing the way for a neat finish.
- **Support material** - Generally support structures are quick and dirty, and so long as the base is adequately supported they can be built as quickly as they can.
- **Bridges** - Having the extrusion span distances depends on the material and cooling. Going too slow will result in sagging, too fast will result in broken strands. Experimentation is the key here, but generally bridging runs slower than perimeters.
- **Gap fill** - Filling in small gaps results in the extruder quickly oscillating and the resulting shaking and resonance could have a detrimental affect on the printer. A smaller value here can guard against this. A setting of zero disables gap filling completely.
- **Travel** - As fast as your printer will allow in order to minimise ooze.
- **First layer speed** - As mentioned in subsection 5.3, the first layer is important to lay down correctly, and a slower pace helps enormously. Setting a value of 50%, or even less, can really help.

Acceleration control is an advanced setting allowing acceleration settings for perimeters, infill, bridge, as well as a default setting, to be made. Deciding which values to set depends on the capabilities of the machine. Any settings within the firmware may be a good starting point.

Take into account any restrictions enforced by the firmware as many have settings for the maximum safe speed of each axis.

Infill Patterns and Density

There are several considerations when choosing an infill pattern: object strength, time and material, personal preference. It can be inferred that a more complex pattern will require more moves, and hence take more time and material.

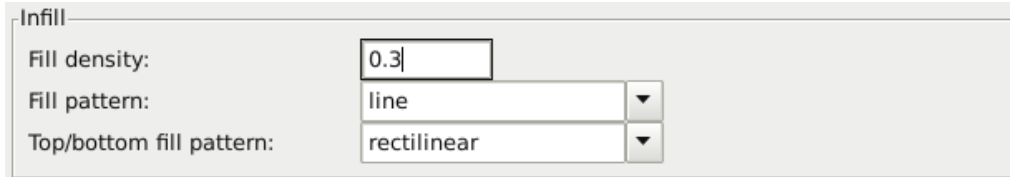

Figure 5.22: Infill pattern settings.

Slic3r offers several infill patterns, four regular, and three more exotic flavours. The numbers given in brackets below each figure are a rough estimate of material used and time taken for a simple 20mm cube model¹⁵. Note that this is only indicative, as model complexity and other factors will affect time and material.

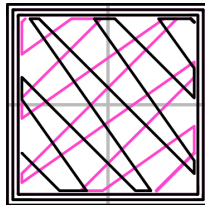

Figure 5.23: Infill pattern: Line (344.51mm / 5m:20s)

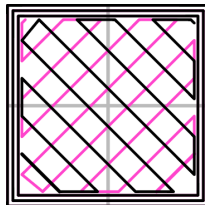

Figure 5.24: Infill pattern: Rectilinear (350.57mm / 5m:23s)

¹⁵Taken from <http://gcode.ws>

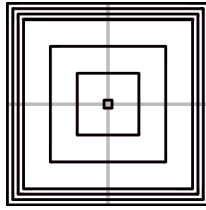

Figure 5.25: Infill pattern: Concentric (351.80mm / 5m:30s)

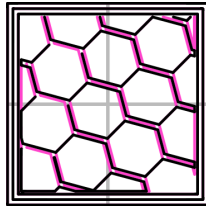

Figure 5.26: Infill pattern: Honeycomb (362.73mm / 5m:39s)

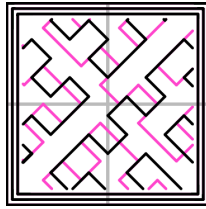

Figure 5.27: Infill pattern: Hilbert Curve (332.82mm / 5m:28s)

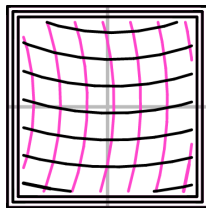

Figure 5.28: Infill pattern: Archimedean Chords (333.66mm / 5m:27s)

5.5. EXPERT MODE

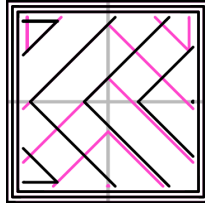

Figure 5.29: Infill pattern: Octagram Spiral (318.63mm / 5m:15s)

Certain model types are more suited for a particular pattern, for example organic versus mechanical types. Figure 5.30 shows how a honeycomb fill may suit this mechanical part better because each hexagon bonds with the same underlying pattern each layer, forming a strong vertical structure.

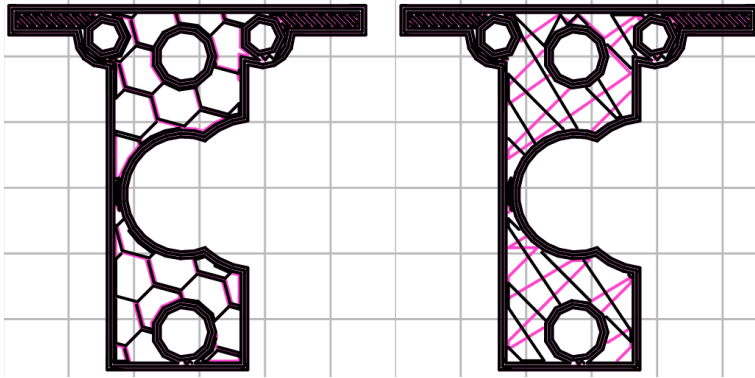

Figure 5.30: Infill pattern comparison in a complex object. Left to Right: honeycomb, line

Most models require only a low density infill, as providing more than, say, 50% will produce a very tightly packed model which uses more material than required. For this reason a common range of patterns is between 10% and 30%, however the requirements of the model will determine which density is best. Figure 5.31 shows how the patterns change as the density increases.

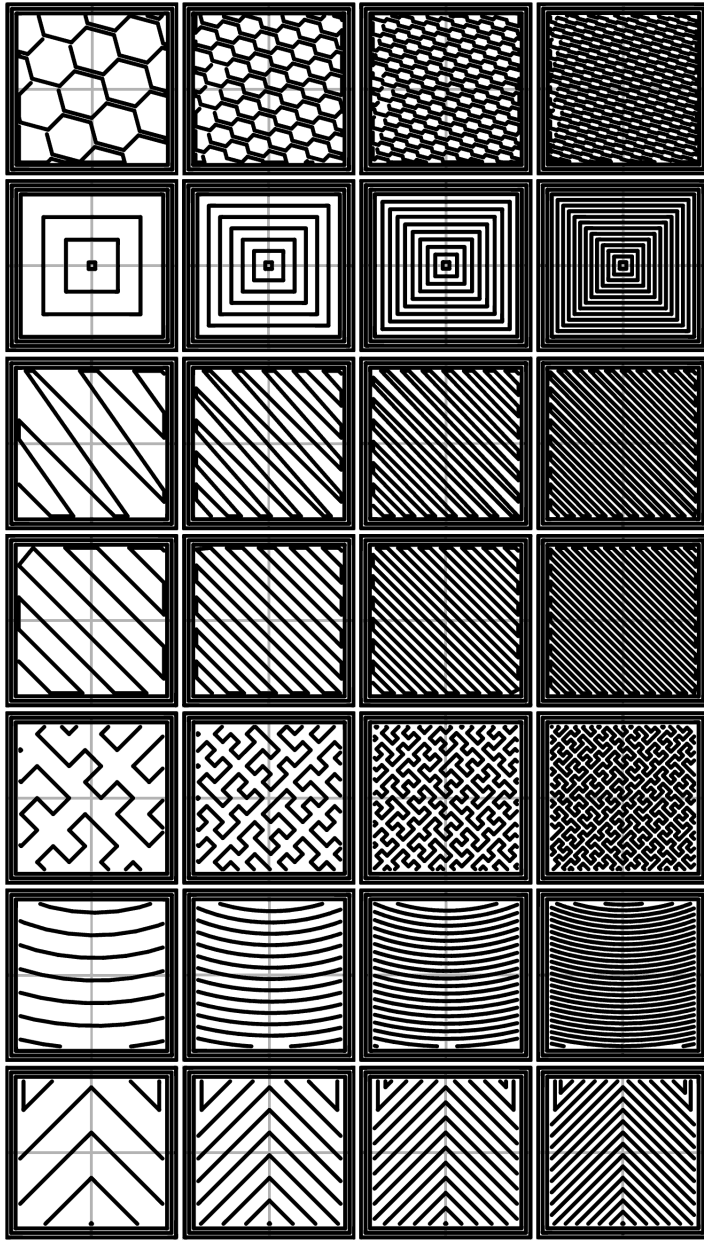

Figure 5.31: Infill patterns at varying densities. Left to Right: 20%,40%,60%,80%. Top to Bottom: Honeycomb, Concentric, Line, Rectilinear, Hilbert Curve, Archimedean Chords, Octagram Spiral

Infill Optimization

Slic3r contains several advanced infill settings which can help produce better extrusions.

Advanced	
Infill every:	2 layers
Only infill where needed:	<input type="checkbox"/>
Solid infill every:	0 layers
Fill angle:	45 °
Solid infill threshold area:	70 mm ²
Only retract when crossing perimeters:	<input checked="" type="checkbox"/>
Infill before perimeters:	<input type="checkbox"/>

Figure 5.32: Infill advanced settings.

- **Infill every n layers** - Will produce sparse vertical infill by skipping a set number of layers. This can be used to speed up print times where the missing infill is acceptable.
- **Only infill where needed** - Slic3r will analyse the model and choose where infill is required in order to support internal ceilings and overhangs. Useful for reducing time and materials.
- **Solid infill every n layers** - Forces a solid fill pattern on the specified layers. Zero will disable this option.
- **Fill angle** - By default the infill pattern runs at 45° to the model to provide the best adhesion to wall structures. Infill extrusions that run adjacent to perimeters are liable to de-laminate under stress. Some models may benefit from rotating the fill angle to ensure the optimal direction of the extrusion.
- **Solid infill threshold area** - Small areas within the model are usually best off being filled completely to provide structural integrity. This will however take more time and material, and can result in parts being unnecessarily solid. Adjust this option to balance these needs.

- **Only retract when crossing perimeters** - Retracting, to prevent ooze, is unnecessary if the extruder remains within the boundaries of the model. Care should be taken if the print material oozes excessively, as not retracting may result in enough material loss to affect the quality of the subsequent extrusion. However, most modern printers and materials rarely suffer from such extreme ooze problems.
- **Infill before perimeters** - Reverses the order in which the layer is printed. Usually the perimeter is laid down initially, followed by the infill, and this is usually the preferable as the perimeter acts as a wall containing the infill.

Fighting Ooze

Unless the material being extruded has a very high viscosity it will ooze from the nozzle in between extrusions. There are several settings in Slic3r to which can help to remedy this.

The retraction settings, found in the **Printer** tab, tell the printer to pull back the filament between extrusion moves. This can alleviate the pressure in the nozzle, thus reducing ooze. After the subsequent travel move the retraction is reversed to prepare the extruder for the next extrusion.

Retraction	
Length:	<input type="text" value="1.6"/> mm (zero to disable)
Lift Z:	<input type="text" value="0"/> mm
Speed:	<input type="text" value="40"/> <input type="button" value="↑"/> <input type="button" value="↓"/> mm/s
Extra length on restart:	<input type="text" value="0"/> mm
Minimum travel after retraction:	<input type="text" value="2"/> mm
Retract on layer change:	<input checked="" type="checkbox"/>

Figure 5.33: Retraction settings.

- **Length** - The number of millimeters to retract. Note that the measurement is taken from the raw filament entering the extruder. A value of between 1 and 2mm is usually recommended. Bowden

5.5. EXPERT MODE

extruders may need up to 4 or 5mm due to the hysteresis introduced by the tube.

- **Lift Z** - Raises the entire extruder on the Z axis by that many millimeters during each travel. This can be useful to ensure the nozzle will not catch on any already laid filament, however it is usually not necessary and will slow the print speed. A value of 0.1mm is usually sufficient.
- **Speed** - The speed at which the extruder motor will pull back the filament. The value should be set to as quick as the extruder can handle without skipping steps, and it is worth experimenting with this value to find the quickest retraction possible.
- **Extra length on restart** - Adds an extra length of filament after the retraction is compensated after the travel move. This setting is rarely used, however should the print show signs of not having enough material after travel moves then it may be useful to add a small amount of additional material.
- **Minimum travel after retraction** - Triggering a retraction after very short moves is usually unnecessary as the amount of ooze is usually insignificant and it slows down the print times. Set the number of millimeters minimum distance the nozzle must move before considering a retraction. If the printer handles ooze well this can be increased to 5 or 6mm.
- **Retract on layer change** - Movement along the Z axis must also be considered when dealing with oozing, otherwise blobs may occur. It is recommended to leave this setting on.
- **Wipe before retract** - Moves the nozzle whilst retracting so as to reduce the chances of a blob forming.

Additionally there are several settings in the **Print** tab which can help control oozing.

- **Only retract when crossing perimeters (Infill)** - Tells Slic3r to only retract if the nozzle will cross the threshold of the current island being extruded. Slight ooze within the walls of a part are not seen and can usually be accepted.

- **Avoid crossing perimeters** (Layers and perimeters - Advanced)
 - Will force the nozzle to follow perimeters as much as possible to minimise the number of times it must cross them when moving around, and between, islands. This has a negative impact on both G-code generation and print times.
- **Randomize starting points** (Layers and perimeters - Vertical shells)
 - As the extruder moves up to the start of the next layer any ooze can result in blobs. If the same start point is used for every layer then a seam can form the length of the object. This setting will move the start point to a different location for each layer.

See also subsection: Sequential Printing, on page 117 for another technique which can minimise strings forming between objects.

Skirt

The **Skirt** setting adds an extrusion a short distance away from the perimeter of the object. This can ensure that the material is flowing smoothly from the extruder before it starts on the model proper.

Skirt		
Loops:	<input type="text" value="2"/>	↕
Distance from object:	<input type="text" value="6"/>	mm
Skirt height:	<input type="text" value="1"/>	↕ layers
Minimum extrusion length:	<input type="text" value="0"/>	mm

Figure 5.34: Skirt settings.

- **Loops** - How many circuits should be completed before starting on the model. One loop is usually sufficient.
- **Distance from object** - The millimeters between the object and the skirt. The default of 6mm is usually sufficient.
- **Skirt height** - The number of layers to lay down a skirt for. For ensuring the material is flowing smoothly, one layer is sufficient,

5.5. EXPERT MODE

however the skirt function can also be used to build walls around the object in case it should be protected from drafts.

- **Minimum extrusion length** - Dictates a minimum number of millimeters that the skirt should be, should the loop around the object not be enough.

Cooling

Temperature plays a key part in determining print quality. Too hot and the material deforms, too cool and layer adhesion may be problematic. Applying cooling will allow the freshly deposited material to solidify enough to provide a good base for the next layer, helping with overhangs, small details and bridges.

There are two main techniques for cooling: adding a fan and slowing down the print speed. Slic3r may choose to use both techniques, using a fan first, and then slowing down the print if the layer time is too fast.

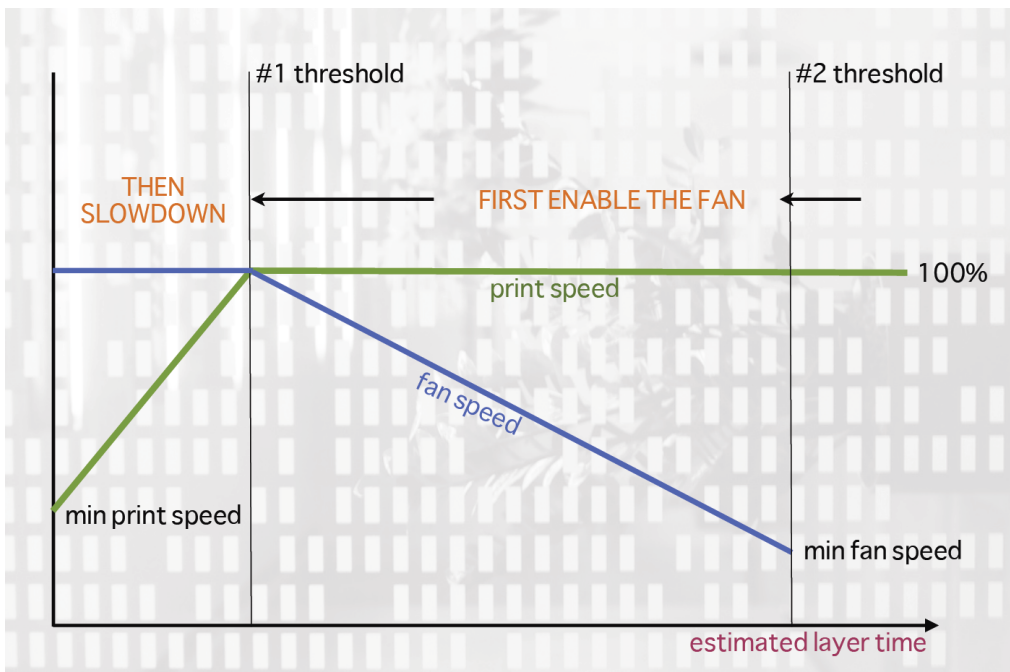

Figure 5.35: Cooling strategy.

Figure 5.35 shows the strategy adopted by Slic3r. Reading from right to left, when the minimum fan threshold (#2) is reached the fan is turned on. This increases in intensity as the layer time decreases. The print speed remains constant until the estimated print time drops below a certain threshold (#1), this is when the print speed is reduced until it reaches it's minimum value.

Fans

Most electronics and firmware allow the addition of a fan via a spare connector. These can then be instructed with G-code, from Slic3r, to turn on or off as the model requires, and to rotate at different speeds.

Care should be taken with the positioning of the fan so that it does not cool any heated bed more than necessary. It should also not cool the heater block of the hot-end so as not to force it to do more work and waste energy. The air movement should aim for the nozzle tip, flowing over the freshly extruded material.

A duct may help in guiding the flow correctly, and there are several designs available online, for a wide variety of printers.

Slowing Down

Slic3r can tell the printer to slow down if the estimated layer time is above a certain threshold.

Care must be taken as the intended effect could be mitigated by the nozzle not moving far enough away from the fresh extrusion, a problem with small, detailed layers. For this reason it is usually recommended to use a fan where possible.

Configuring

In simple mode Slic3r will attempt to choose the optimal settings for both fans and speed. Expert mode gives more granular options.

5.5. EXPERT MODE

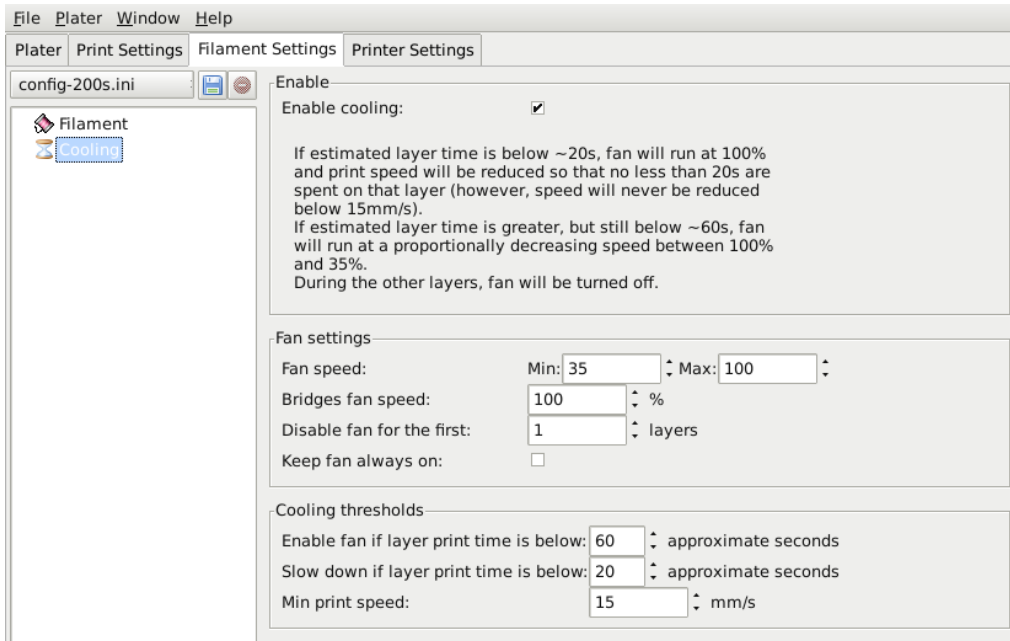

Figure 5.36: Cooling advanced settings.

- **Fan speed** - Determines the minimum and maximum speeds - useful for fans that run too fast by default.
- **Bridges fan speed** - As the material stretches over wide gaps, it makes sense to try and cool it as much as possible, therefore a full fan speed is recommended.
- **Disable fan for first n layers** - Section 5.3 detailed how important the first layer is, and so it makes sense not to apply the fan until sure the print is securely attached to the bed. Keeping the fan turned off for the first two or three layers is a good idea.
- **Keep fan always on** - Overrides any other choices and has the fan run continuously, at least at the minimum speed setting. This can be useful when printing with PLA, but is not recommended for ABS.
- **Enable fan if print time is below t seconds** - Triggers the fan if the layer will be completed within the given number of seconds.

- `Slow down if layer print time is below t seconds` - Slows down the print if the layer will be completed within the given number of seconds.
- `Min print speed` - A lower limit on how slowly a layer can be printed.

Support Material

Generally, most 3D models will print with overhanging parts by up to a certain degree. The angle is determined by several factors, most notably layer height and extrusion width, and is usually around 45° . For models with larger overhangs a support structure may have to be printed below it. This incurs the use of more material, longer print times, and post printing clean-up.

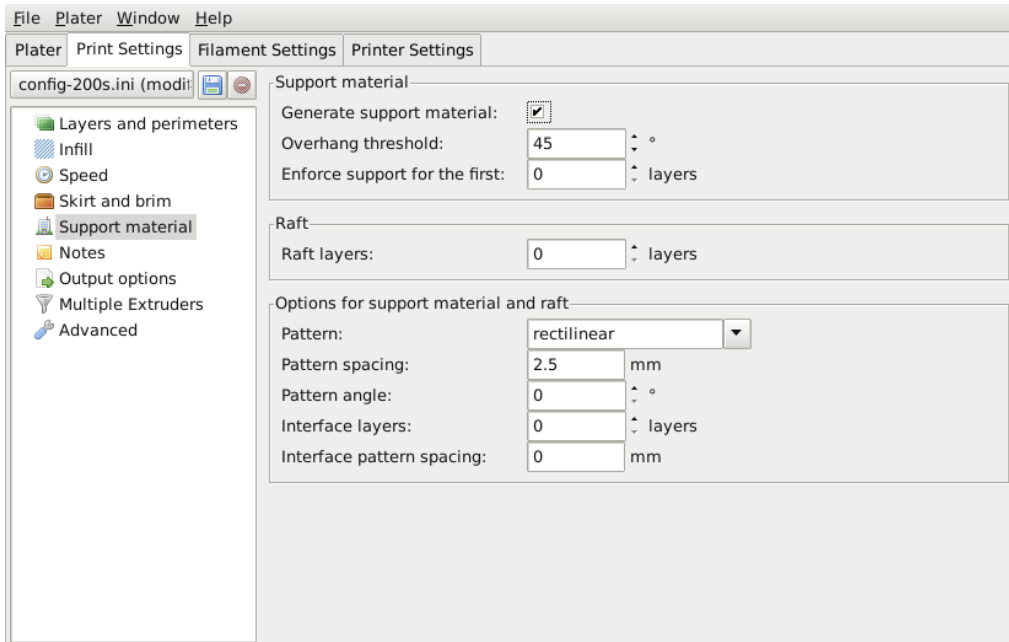

Figure 5.37: Support structure options.

The first thing to do is activate the support material option by checking the `Generate support material` box. Providing a value of zero to the `Overhang threshold` parameter tells Slic3r to detect places to provide

5.5. EXPERT MODE

support automatically, otherwise the degrees given will be used. Support generation is a relatively complex topic, and there are several aspects which determine the optimal support, it is strongly recommended to set the threshold to zero and allow Slic3r to determine the support required.

Small models, and those with small footprints, can sometimes break or detach from the bed. Therefore the **Enforce support** option will cause support structures to be printed for the given number of layers, regardless of the angle threshold value.

To demonstrate the infill patterns the minimug model was tilted by 45° along the x axis, as shown in figure 5.38.

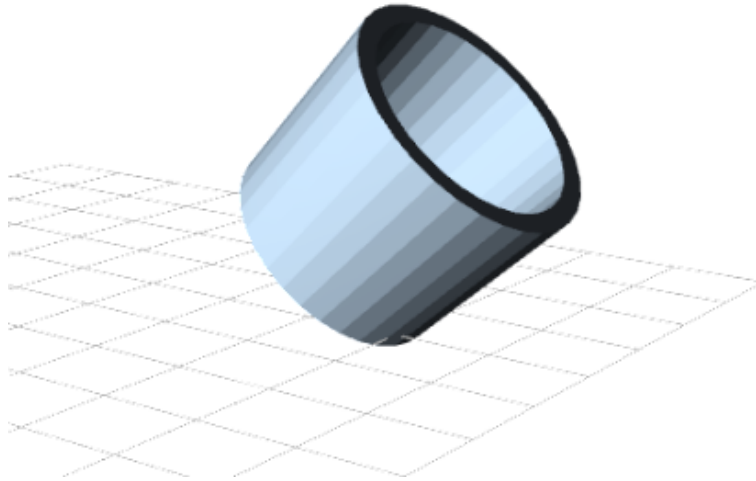

Figure 5.38: Minimug model, tilted 45° .

As with infill, there are several patterns available for the support structure.



Figure 5.39: Support infill pattern: Rectilinear

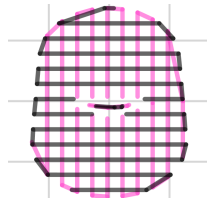

Figure 5.40: Support infill pattern: Rectilinear Grid

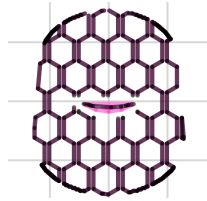

Figure 5.41: Support infill pattern: Honeycomb

Pattern Spacing determines the distance between support lines, and is akin to infill density apart from being defined only in mm. If changing this attribute take into account the width of the support extrusion and the amount of support material that will adhere to the object.

Care should be taken to choose a support pattern which matches the model, where the support material attaches perpendicularly to the wall of the object, rather than in parallel, so it will be easy to remove. If the support structure does run along the length of a wall then the **Pattern Angle** option allows the direction of the support lines to be rotated.

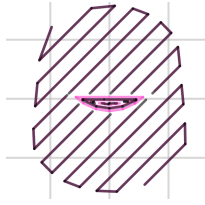

Figure 5.42: Example of pattern angle rotated 45°.

Multiple Extruders

A printer with more than one extruder can be used in different ways: The additional extruder could print a different color or material; or it could be assigned to print particular features, such as infill, support or perimeters.

Multi-material printing requires a suitably designed object usually written in AMF format as this can handle multiple materials (see Model Formats in §5.3). Details on how to create such a file are given below.

Configuring Extruders

In the **Printer Settings** tab there is an **Extruders** option, under **Capabilities**, which allows the number of extruders to be defined. Incrementing this value will dynamically add another extruder definition to the left-hand pane.

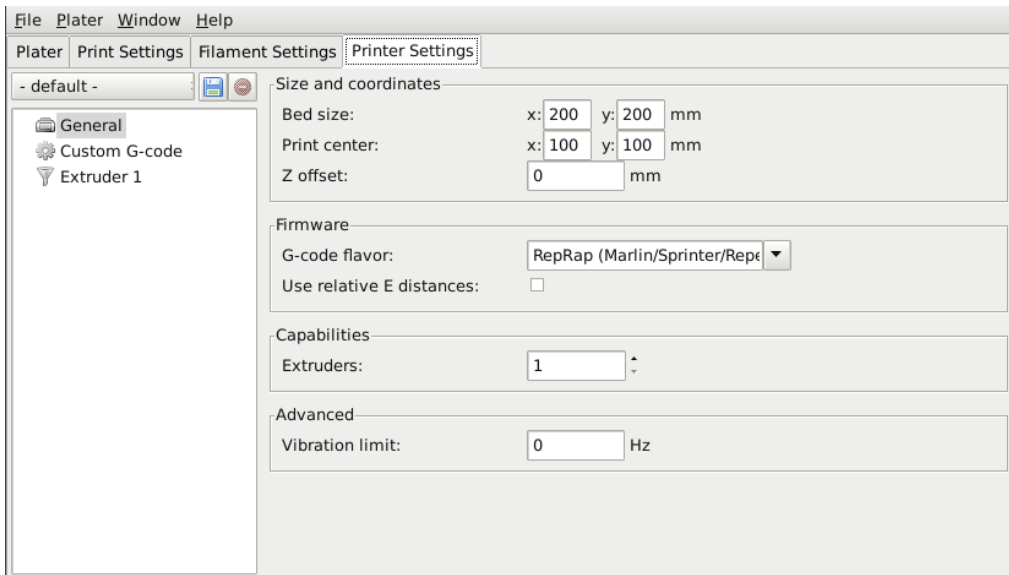

Figure 5.43: Multiple extruder options - Printer Settings Tab (General). Note the two extruders defined in the left-hand pane.

Each extruder can be configured as usual, however there are additional settings which must be set which are particular to multi-extruder setups.

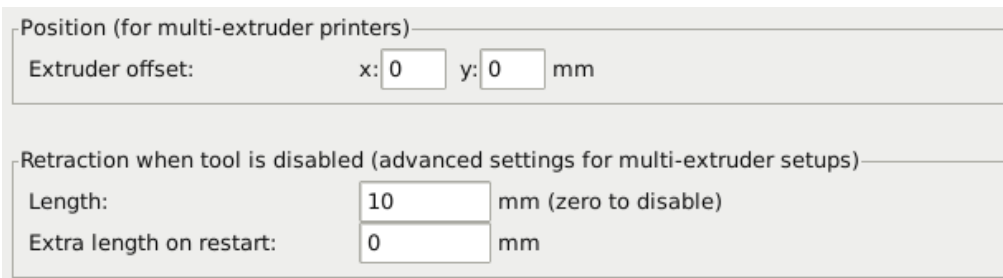

Figure 5.44: Multiple extruder options - Printer Settings Tab (Extruder).

The **Extruder offset** is to be used should the firmware not handle the displacement of each additional nozzle. Your firmware documentation should tell you if this is the case. Each additional extruder is given an offset in relation to the first one. If the firmware does handle this then all offsets can remain at 0,0.

5.5. EXPERT MODE

Because the secondary extruder will be dormant whilst the first is working, and vice-versa, it is important that the material is sufficiently retracted to stop oozing. As with the regular retraction settings (see p.94) the **Length** options is measured from the raw filament entering the extruder.

Assigning Filaments

When a printer profile with multiple extruders has been selected the **Plater** tab allows the selection of a different filament for each extruder.

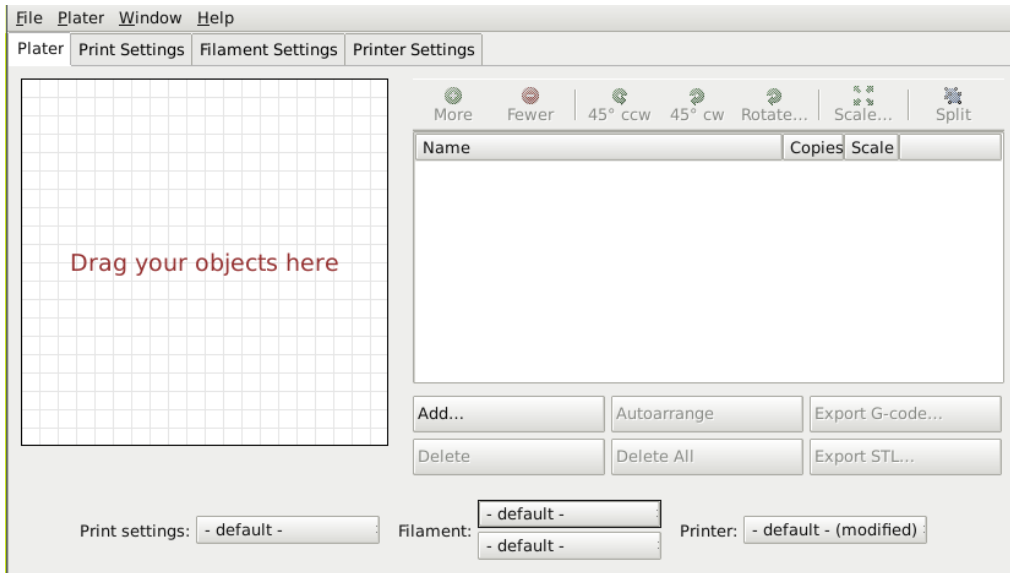

Figure 5.45: Plater with multiple filament options.

Assigning Extruders for Single-material Objects

For single material prints, where the secondary extruder is to be tasked with a particular extrusion, the **Multiple Extruders** subsection of the **Print Settings** tab gives the ability to assign an extruder to each extrusion type.

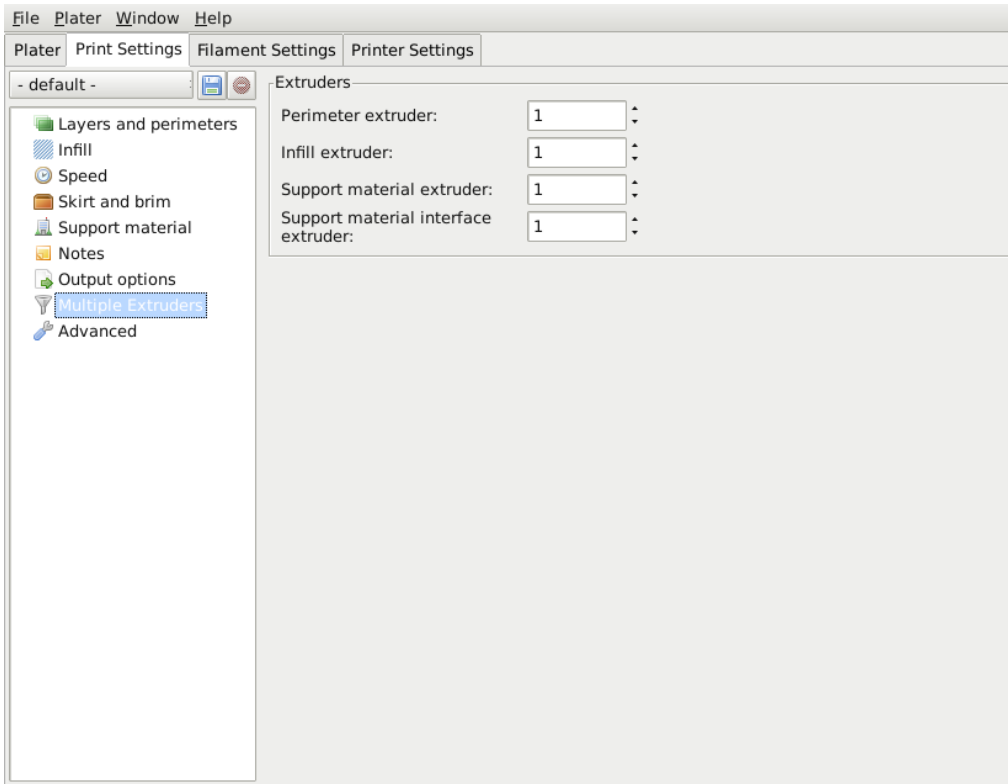

Figure 5.46: Multiple extruder options - Print Settings Tab.

Configuring Tool Changes

The **Custom G-code** subsection of the **Printer Settings** tab has an option for inserting G-code between tool changes. As with all custom G-code subsections, placeholder variables can be used to reference Slic3r settings. This includes the `[previous_extruder]` and `[next_extruder]` variables.

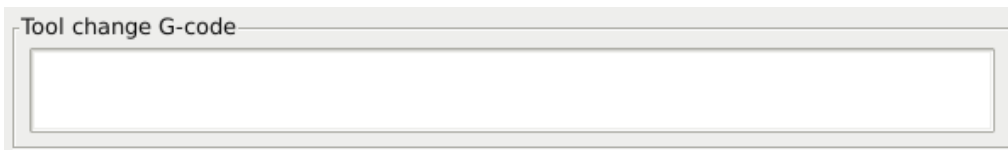

Figure 5.47: Multiple extruder options - Tool change G-code.

Printing Multi-material Objects

If a multi-material AMF file already exists, because the CAD program can export such a format, then this can be loaded into Slic3r in the usual way. The mapping between object materials and extruders is sequential, i.e. the first material is assigned to the first extruder, etc.

Generating multi-material AMF files

Slic3r has the feature to combine multiple STL files into a multi-material AMF file.

- Split the original design into the separate parts within the CAD program, and export each part as STL.
- Within Slic3r, choose **Combine multi-material STL files...** from the **File** menu.
- When prompted with a file dialog, choose the first STL, which will be assigned the first material (and hence the first extruder). Click **Open** to be prompted for the next STL, and so on until each STL is assigned a material. To signal there are no more STL files, choose **Cancel**.
- The following file dialog prompts for the location and name of the AMF file.

Once generated the file can be loaded and printed as described above.

Extrusion Width

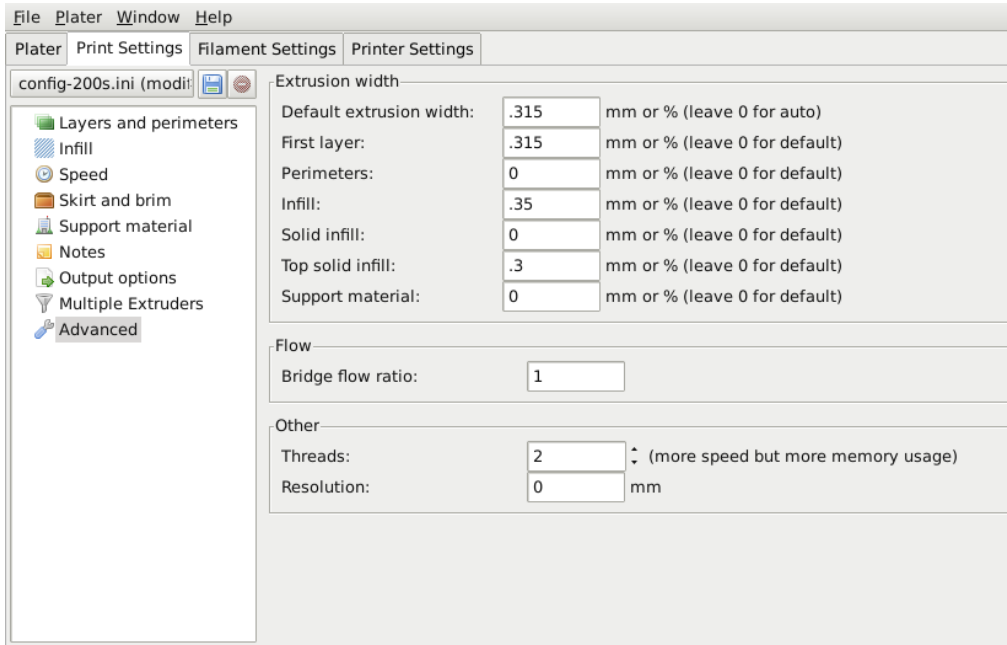

Figure 5.48: Extrusion widths options.

One reason for modifying the extrusion width has already been discussed: increasing first layer extrusion width in order to improve bed adhesion (see p.71). There are some further cases where it may be beneficial to modify extrusion widths.

- **Perimeter** - A lower value will produce thinner extrusions which in turn will produce more accurate surfaces.
- **Infill and Solid Infill** - A thicker extrusion for infill will produce faster prints and stronger parts.
- **Top infill** - A thinner extrusion will improve surface finish and ensure corners are tightly filled.
- **Support material** - As with the infill options, a thicker extrusion will speed up print time.

It is important to remember that if the extrusion width is expressed as a percentage then this is computed from the `Layer height` property, and not the `Default extrusion width` setting.

Variable Layer Height

Slic3r gives the ability to adjust the layer height between arbitrary positions along the Z axis. That is, parts of the model could be printed with a coarse layer height, for example vertical subsections, and other parts could be printed with a finer layer height, for example sloping gradients where layering appears more pronounced.

The model in fig. 5.49 gives a rudimentary example of where variable layer heights could be used to improve print quality. The walls of the structure need not be rendered in high definition for acceptable quality, however the sloping roof shows layer artifacts as the layer height of 0.4mm is too coarse, particularly for the very top, which is flattened. This is shown in the G-Code rendering in fig 5.50.

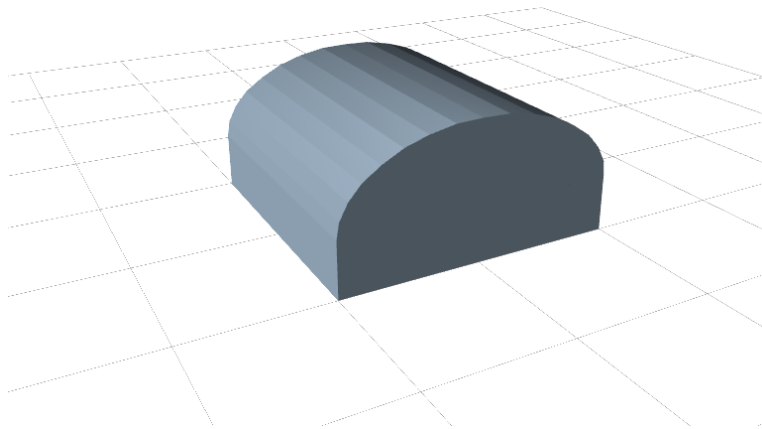

Figure 5.49: Example model highlighting use case for variable layer heights.

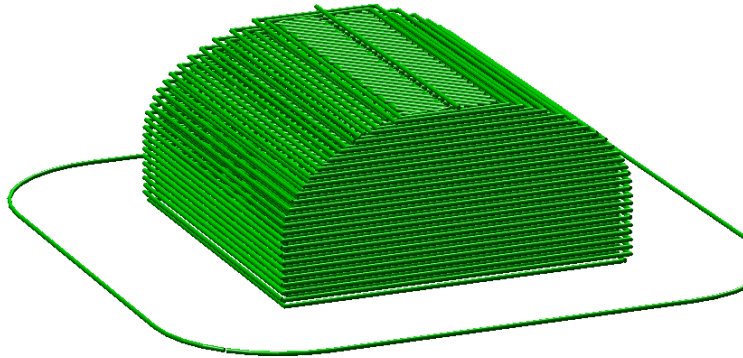

Figure 5.50: Example with normal layer height.

The variable layer height options are available by double clicking on a part name in the Plater window. This will cause a pop-up window to be displayed which contains two tabs. The first gives some information about the model, as shown in fig. 5.51.

5.5. EXPERT MODE

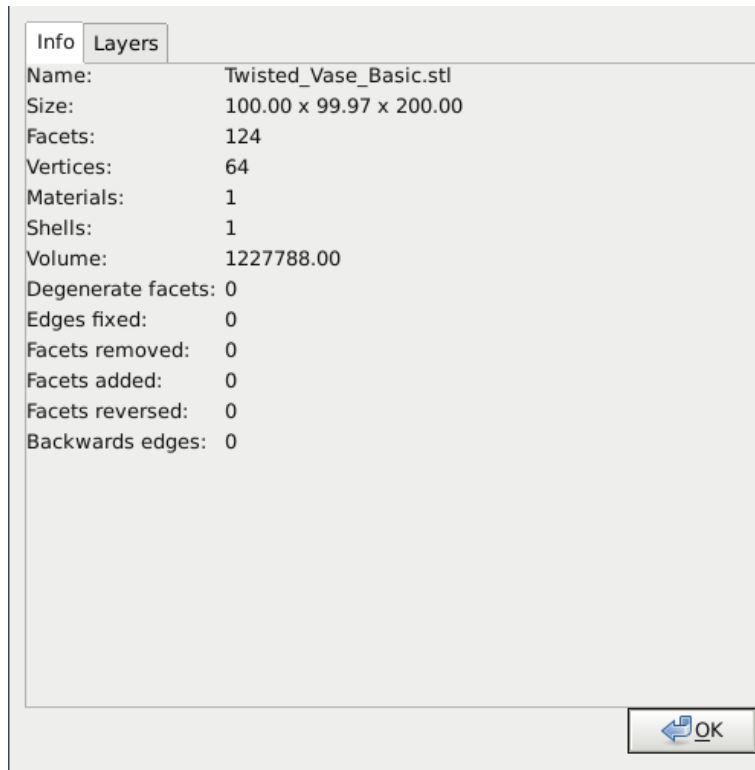

Figure 5.51: Variable layer height options - Info.

It is worth noting the height of the model, as this will be useful when calculating the maximum Z height.

The second tab (fig. 5.52) presents a table where each row defines a layer height for a particular range along the Z axis, given in millimeters. In this example the walls of the model are printed at 0.4mm, the steeper parts of the roof are printed at 0.2mm, and the less steep at 0.15mm. Note that each range divides exactly by the given layer height so there are no "gaps" between subsections.

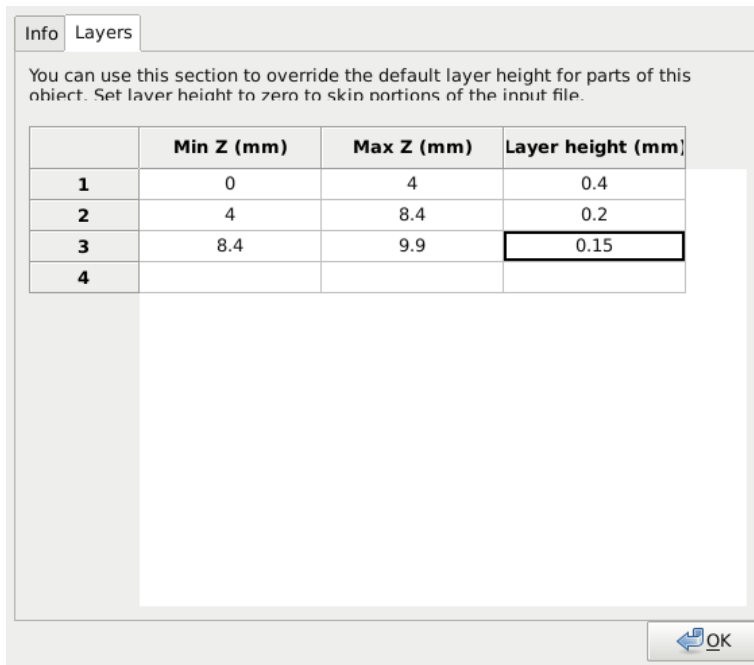

Figure 5.52: Variable layer height options - Layers.

The resulting G-Code (fig. 5.53) shows a higher definition which should result in a higher quality print.

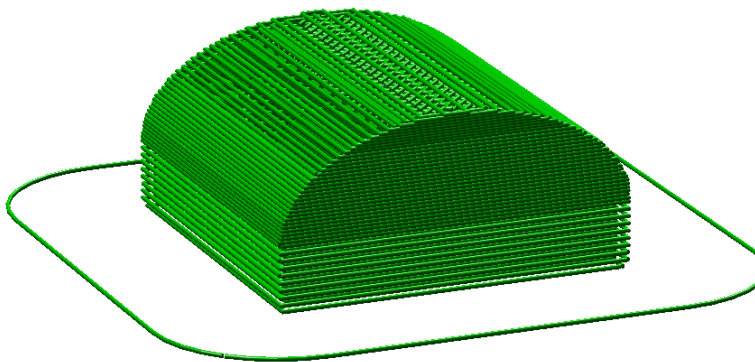

Figure 5.53: Example with variable layer height.

5.5. EXPERT MODE

Fig. 5.54 shows the example model printed. The print on the left has 0.4mm layer height throughout, whereas the print on the right has the variable layer height.

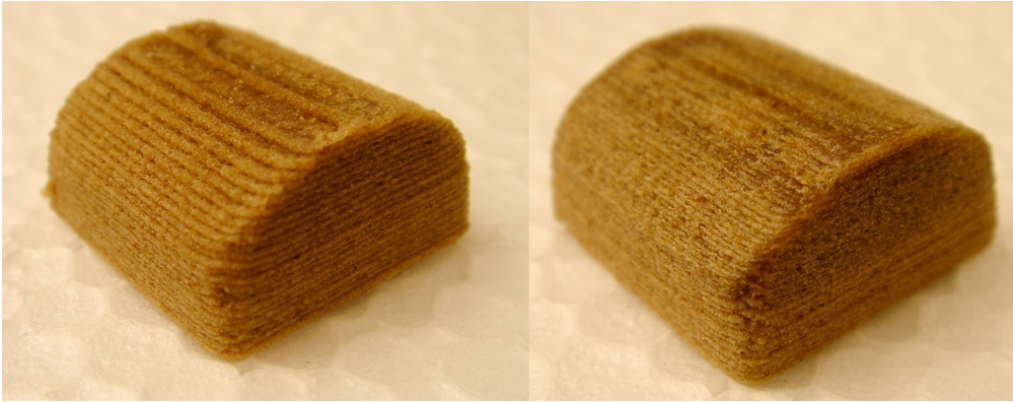

Figure 5.54: Example print with variable layer height.

An additional feature of the variable layers height option is that by entering a zero for a range that part of the model will not be printed. Fig. 5.55 shows the G-Code where layers between 0 and 4mm are skipped. This is a useful way of dividing a tall model into multiple, shorter subsections which can be printed individually and assembled afterwards.

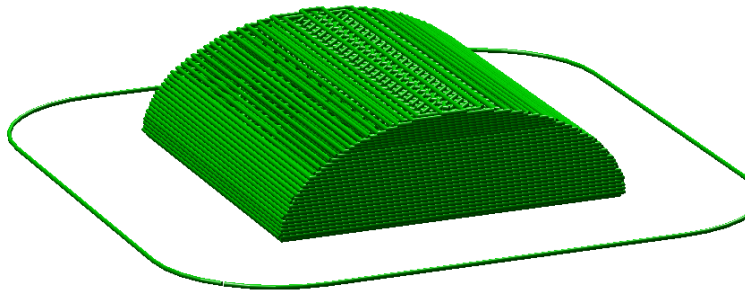

Figure 5.55: Example with skipped layers.

5.6 Configuration Organization

There are two ways in which to organize the configuration settings: exporting and importing the configuration settings, and profiles. The former is available in both simple and expert mode, whereas profiles is only available in expert mode.

Exporting and Importing Configuration

The current set of configuration options can be simply exported via the **Export Config File** menu option. This saves all the values into a text file with a `.ini` extension. Previously saved files can be loaded with the **Load Config** menu option.

This gives a rudimentary means to store different configuration settings for different needs. For example a set with slightly faster print speeds, or a different infill pattern. However this way of organizing things will quickly become frustrating, as each minor change to a parameter may have to be duplicated across many configurations. For this reason, profiles are a more suitable way of managing multiple configurations.

This method also allows configuration to be transferred between machines, or stored remotely.

Profiles

After a few prints it will become apparent that it is worth having a set of configuration options to choose from, and that some parameters change at different rates as others. In expert mode, profiles can be created for Print, Filament and Printer settings, with the expectation that the printer settings change least often, filament rarely, and the print settings could be changed for each model. These different profiles can be mixed and matched as desired, and can be selected either in their respective tabs, or directly from the plater.

Creating Profiles

Open the desired tab and change the settings as necessary. Once satisfied, click the save icon to the left above the setting titles, and give a suitable name when prompted.

5.6. CONFIGURATION ORGANIZATION

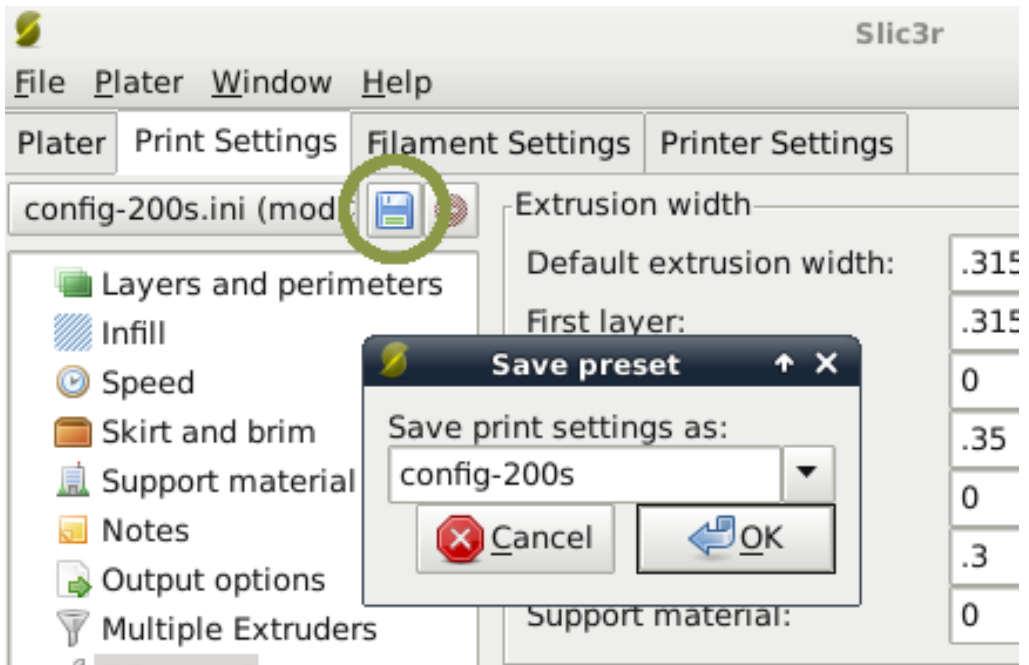

Figure 5.56: Saving a profile.

Profiles can be deleted by choosing the profile to delete and clicking the red delete button next to the save button.

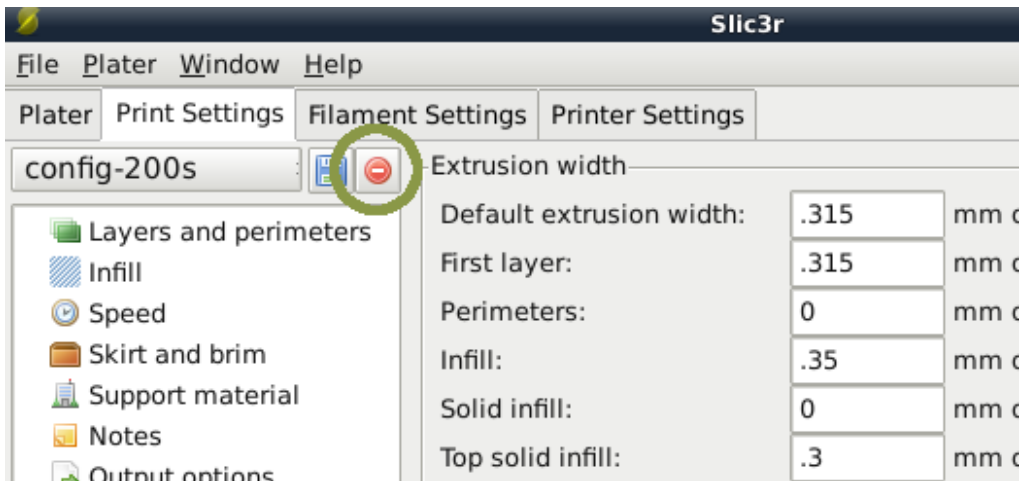

Figure 5.57: Deleting a profile.

5.7 Repairing Models

If the 3D mesh described in the model contains holes, or edges are misaligned (known as being non-manifold), then Slic3r may have problems working on it. Slic3r will attempt to fix any problems it can, but some problems are out of its reach. If the application complains that a model cannot be sliced correctly then there are several options available, and the ones described here are all free at the time of writing.

FreeCAD FreeCAD¹⁶ is a comprehensive, and free, CAD program which comes with a mesh module, in which repairs to degenerate models can be made. The following steps outline how a problem model file can be analysed and repaired.

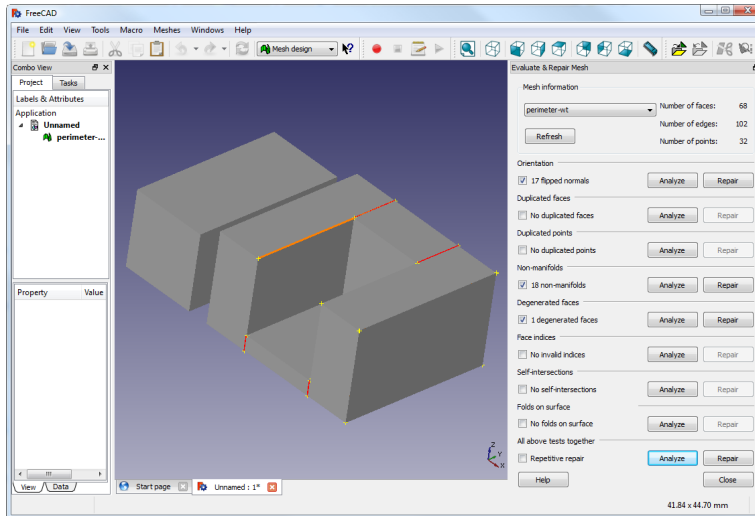

Figure 5.58: FreeCAD part repair.

- Start FreeCAD and from the start splash page choose **Working with Meshes**.
- Load the model by dragging and dropping it onto the workspace or via the **File** menu. A small message in the bottom left corner will indicate if the model appears to have problems.

¹⁶<http://sourceforge.net/projects/free-cad>

- From the menu choose **Meshes->Analyze->Evaluate & Repair mesh** to bring up the repair options dialog.
- From the options dialog choose the loaded mesh, then perform each analysis by clicking the **Analyze** button by each problem type, or select **Repetitive Repair** at the bottom to perform all checks. If a corresponding problem is detected the **Repair** button becomes enabled.
- For each desired repair hit the **Repair** button.
- It is important to review the effect the repair script has made to the model. It may be the case that the script damages the file, rather than repair, for example by removing important triangles.
- Export the repaired model via the **Export** menu option or context menu.

5.8 Advanced Topics

Sequential Printing

When printing several objects at once it can be useful to print each one separately as this will minimise oozing and strings running between the prints. It will also decrease the risk of a problem ruining the entire print - if one part detaches or fails in some way, it will not be dragged into other parts of the print during each layer.

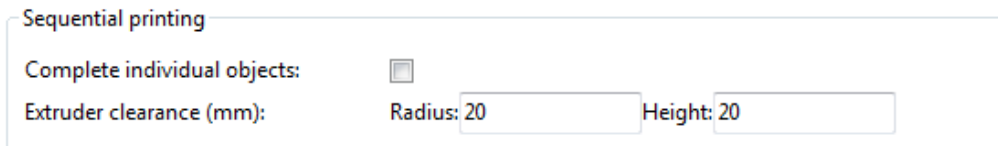

Figure 5.59: Sequential printing options.

Care has to be taken that the nozzle and extruder does not interfere with already printed parts. Slic3r should warn if it detects the nozzle or extruder will collide with a part, but double check that the layout of the

parts will not cause problems. The `Extruder clearance` parameters help Slic3r detect potential collisions:

- **Radius** - The clearance that should be given around the extruder. Take care if the extruder is not mounted centrally - take the largest safe value.
- **Height** - The vertical distance between the nozzle tip and the X axis rods, or lowest part which may interfere with a finished print.

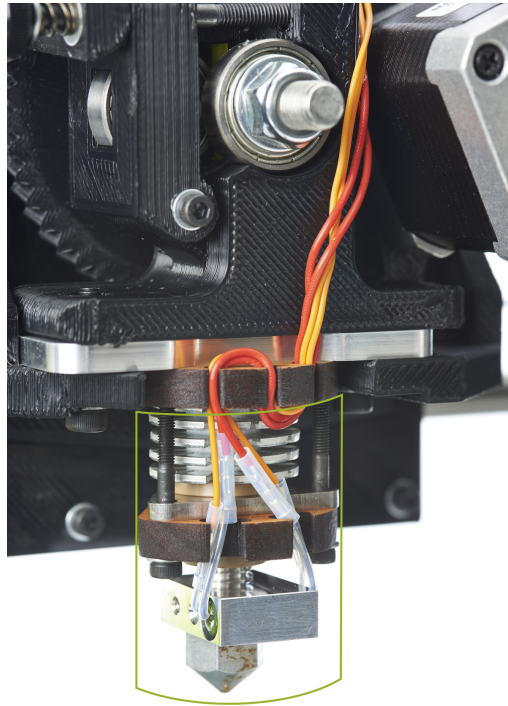

Figure 5.60: The clearance cylinder around an extruder.

Command Line Usage

Slic3r can also be used from the command line instead of via the GUI, as part of a script, or as part of another tool, such as Printron¹⁷.

All options found in the GUI can be used from the command line in the form of switch parameters. The latest version of these are given below, and the most up-to-date information can be found by issuing the command:

```
perl slic3r.pl --help
```

Preset configurations can be loaded from a .ini file using the `--load` option, and options can be overridden further on the command line, e.g.

```
perl slic3r.pl --load config.ini --layer-height 0.25
file.stl
```

Command Line Options

Usage: slic3r.pl [OPTIONS] file.stl

```
--help           Output this usage screen and exit
--version        Output the version of Slic3r and exit
--save <file>   Save configuration to the specified file
--load <file>   Load configuration from the specified file. It can be used
               more than once to load options from multiple files.
-o, --output <file> File to output gcode to (by default, the file will be saved
               into the same directory as the input file using the
               --output-filename-format to generate the filename)
-j, --threads <num> Number of threads to use (1+, default: 2)
```

GUI options:

```
--no-plater      Disable the plater tab
--gui-mode       Overrides the configured mode (simple/expert)
```

Output options:

```
--output-filename-format
               Output file name format; all config options enclosed in brackets
               will be replaced by their values, as well as [input_filename_base]
               and [input_filename] (default: [input_filename_base].gcode)
--post-process   Generated G-code will be processed with the supplied script;
               call this more than once to process through multiple scripts.
--export-svg     Export a SVG file containing slices instead of G-code.
-m, --merge     If multiple files are supplied, they will be composed into a single
               print rather than processed individually.
```

Printer options:

```
--nozzle-diameter Diameter of nozzle in mm (default: 0.5)
--print-center    Coordinates in mm of the point to center the print around
               (default: 100,100)
--z-offset        Additional height in mm to add to vertical coordinates
               (+/-, default: 0)
```

¹⁷<https://github.com/kliment/Printrun>

```

--gcode-flavor      The type of G-code to generate
                    (reprap/teacup/makerbot/sailfish/mach3/no-extrusion, default: reprap)
--use-relative-e-distances Enable this to get relative E values
--gcode-arcs       Use G2/G3 commands for native arcs (experimental, not supported
                    by all firmwares)
--g0               Use G0 commands for retraction (experimental, not supported by all
                    firmwares)
--gcode-comments   Make G-code verbose by adding comments (default: no)
--vibration-limit  Limit the frequency of moves on X and Y axes (Hz, set zero to disable;
                    default: 0)

Filament options:
--filament-diameter Diameter in mm of your raw filament (default: 3)
--extrusion-multiplier
                    Change this to alter the amount of plastic extruded. There should be
                    very little need to change this value, which is only useful to
                    compensate for filament packing (default: 1)
--temperature      Extrusion temperature in degree Celsius, set 0 to disable (default: 200)
--first-layer-temperature Extrusion temperature for the first layer, in degree Celsius,
                    set 0 to disable (default: same as --temperature)
--bed-temperature  Heated bed temperature in degree Celsius, set 0 to disable (default: 0)
--first-layer-bed-temperature Heated bed temperature for the first layer, in degree Celsius,
                    set 0 to disable (default: same as --bed-temperature)

Speed options:
--travel-speed      Speed of non-print moves in mm/s (default: 130)
--perimeter-speed   Speed of print moves for perimeters in mm/s (default: 30)
--small-perimeter-speed
                    Speed of print moves for small perimeters in mm/s or % over perimeter speed
                    (default: 30)
--external-perimeter-speed
                    Speed of print moves for the external perimeter in mm/s or % over perimeter speed
                    (default: 70%)
--infill-speed      Speed of print moves in mm/s (default: 60)
--solid-infill-speed Speed of print moves for solid surfaces in mm/s or % over infill speed
                    (default: 60)
--top-solid-infill-speed Speed of print moves for top surfaces in mm/s or % over solid infill speed
                    (default: 50)
--support-material-speed
                    Speed of support material print moves in mm/s (default: 60)
--bridge-speed      Speed of bridge print moves in mm/s (default: 60)
--gap-fill-speed    Speed of gap fill print moves in mm/s (default: 20)
--first-layer-speed Speed of print moves for bottom layer, expressed either as an absolute
                    value or as a percentage over normal speeds (default: 30%)

Acceleration options:
--perimeter-acceleration
                    Overrides firmware's default acceleration for perimeters. (mm/s^2, set zero
                    to disable; default: 0)
--infill-acceleration
                    Overrides firmware's default acceleration for infill. (mm/s^2, set zero
                    to disable; default: 0)
--bridge-acceleration
                    Overrides firmware's default acceleration for bridges. (mm/s^2, set zero
                    to disable; default: 0)
--default-acceleration
                    Acceleration will be reset to this value after the specific settings above

```

5.8. ADVANCED TOPICS

have been applied. (mm/s², set zero to disable; default: 130)

Accuracy options:

```
--layer-height      Layer height in mm (default: 0.4)
--first-layer-height Layer height for first layer (mm or %, default: 0.35)
--infill-every-layers
                    Infill every N layers (default: 1)
--solid-infill-every-layers
                    Force a solid layer every N layers (default: 0)
```

Print options:

```
--perimeters        Number of perimeters/horizontal skins (range: 0+, default: 3)
--top-solid-layers   Number of solid layers to do for top surfaces (range: 0+, default: 3)
--bottom-solid-layers Number of solid layers to do for bottom surfaces (range: 0+, default: 3)
--solid-layers       Shortcut for setting the two options above at once
--fill-density        Infill density (range: 0-1, default: 0.4)
--fill-angle          Infill angle in degrees (range: 0-90, default: 45)
--fill-pattern        Pattern to use to fill non-solid layers (default: honeycomb)
--solid-fill-pattern  Pattern to use to fill solid layers (default: rectilinear)
--start-gcode         Load initial G-code from the supplied file. This will overwrite
                    the default command (home all axes [G28]).
--end-gcode           Load final G-code from the supplied file. This will overwrite
                    the default commands (turn off temperature [M104 S0],
                    home X axis [G28 X], disable motors [M84]).
--layer-gcode         Load layer-change G-code from the supplied file (default: nothing).
--toolchange-gcode    Load tool-change G-code from the supplied file (default: nothing).
--extra-perimeters   Add more perimeters when needed (default: yes)
--randomize-start     Randomize starting point across layers (default: yes)
--avoid-crossing-perimeters Optimize travel moves so that no perimeters are crossed (default: no)
--external-perimeters-first Reverse perimeter order. (default: no)
--only-retract-when-crossing-perimeters
                    Disable retraction when travelling between infill paths inside the same island.
                    (default: no)
--solid-infill-below-area
                    Force solid infill when a region has a smaller area than this threshold
                    (mm2, default: 70)
--infill-only-where-needed
                    Only infill under ceilings (default: no)
--infill-first        Make infill before perimeters (default: no)
```

Support material options:

```
--support-material   Generate support material for overhangs
--support-material-threshold
                    Overhang threshold angle (range: 0-90, set 0 for automatic detection,
                    default: 0)
--support-material-pattern
                    Pattern to use for support material (default: rectilinear)
--support-material-spacing
                    Spacing between pattern lines (mm, default: 2.5)
--support-material-angle
                    Support material angle in degrees (range: 0-90, default: 0)
--support-material-interface-layers
                    Number of perpendicular layers between support material and object
                    (0+, default: 0)
--support-material-interface-spacing
                    Spacing between interface pattern lines
                    (mm, set 0 to get a solid layer, default: 0)
```

```
--raft-layers      Number of layers to raise the printed objects by (range: 0+, default: 0)
--support-material-enforce-layers
                    Enforce support material on the specified number of layers from bottom,
                    regardless of --support-material and threshold (0+, default: 0)
```

Retraction options:

```
--retract-length  Length of retraction in mm when pausing extrusion (default: 1)
--retract-speed    Speed for retraction in mm/s (default: 30)
--retract-restart-extra
                    Additional amount of filament in mm to push after
                    compensating retraction (default: 0)
--retract-before-travel
                    Only retract before travel moves of this length in mm (default: 2)
--retract-lift     Lift Z by the given distance in mm when retracting (default: 0)
--retract-layer-change
                    Enforce a retraction before each Z move (default: yes)
--wipe             Wipe the nozzle while doing a retraction (default: no)
```

Retraction options for multi-extruder setups:

```
--retract-length-toolchange
                    Length of retraction in mm when disabling tool (default: 1)
--retract-restart-extra-toolchange
                    Additional amount of filament in mm to push after
                    switching tool (default: 0)
```

Cooling options:

```
--cooling          Enable fan and cooling control
--min-fan-speed     Minimum fan speed (default: 35%)
--max-fan-speed     Maximum fan speed (default: 100%)
--bridge-fan-speed Fan speed to use when bridging (default: 100%)
--fan-below-layer-time Enable fan if layer print time is below this approximate number
                    of seconds (default: 60)
--slowdown-below-layer-time Slow down if layer print time is below this approximate number
                    of seconds (default: 30)
--min-print-speed   Minimum print speed (mm/s, default: 10)
--disable-fan-first-layers Disable fan for the first N layers (default: 1)
--fan-always-on     Keep fan always on at min fan speed, even for layers that don't need
                    cooling
```

Skirt options:

```
--skirts          Number of skirts to draw (0+, default: 1)
--skirt-distance   Distance in mm between innermost skirt and object
                    (default: 6)
--skirt-height     Height of skirts to draw (expressed in layers, 0+, default: 1)
--min-skirt-length Generate no less than the number of loops required to consume this length
                    of filament on the first layer, for each extruder (mm, 0+, default: 0)
--brim-width       Width of the brim that will get added to each object to help adhesion
                    (mm, default: 0)
```

Transform options:

```
--scale           Factor for scaling input object (default: 1)
--rotate          Rotation angle in degrees (0-360, default: 0)
--duplicate        Number of items with auto-arrange (1+, default: 1)
--bed-size         Bed size, only used for auto-arrange (mm, default: 200,200)
--duplicate-grid   Number of items with grid arrangement (default: 1,1)
--duplicate-distance Distance in mm between copies (default: 6)
```

5.8. ADVANCED TOPICS

Sequential printing options:

- complete-objects When printing multiple objects and/or copies, complete each one before starting the next one; watch out for extruder collisions (default: no)
- extruder-clearance-radius Radius in mm above which extruder won't collide with anything (default: 20)
- extruder-clearance-height Maximum vertical extruder depth; i.e. vertical distance from extruder tip and carriage bottom (default: 20)

Miscellaneous options:

- notes Notes to be added as comments to the output file
- resolution Minimum detail resolution (mm, set zero for full resolution, default: 0)

Flow options (advanced):

- extrusion-width Set extrusion width manually; it accepts either an absolute value in mm (like 0.65) or a percentage over layer height (like 200%)
- first-layer-extrusion-width Set a different extrusion width for first layer
- perimeter-extrusion-width Set a different extrusion width for perimeters
- infill-extrusion-width Set a different extrusion width for infill
- solid-infill-extrusion-width Set a different extrusion width for solid infill
- top-infill-extrusion-width Set a different extrusion width for top infill
- support-material-extrusion-width Set a different extrusion width for support material
- bridge-flow-ratio Multiplier for extrusion when bridging (> 0, default: 1)

Multiple extruder options:

- extruder-offset Offset of each extruder, if firmware doesn't handle the displacement (can be specified multiple times, default: 0x0)
- perimeter-extruder Extruder to use for perimeters (1+, default: 1)
- infill-extruder Extruder to use for infill (1+, default: 1)
- support-material-extruder Extruder to use for support material (1+, default: 1)

Post-Processing Scripts

There may be times when the G-Code generated by Slic3r has to be tweaked or modified after it has been created. For this reason there exists the ability to run arbitrary scripts as part of the final steps in the slicing process¹⁸.

In the **Output options** subsection of the **Print Settings** tab lies the **Post-processing scripts** option. The absolute path to each script can be added, separated by semicolons. Each script should be recognised by the host system, and be executable.

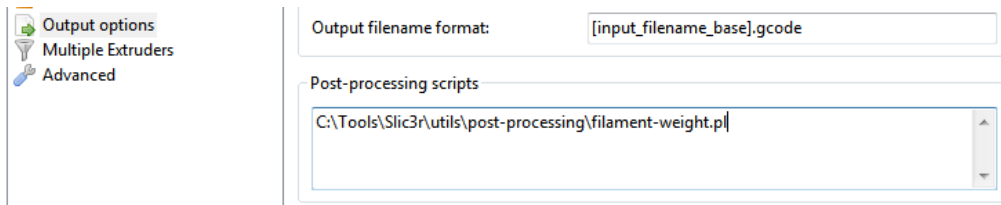

Figure 5.61: Post-processing script option.

Each script will be passed the absolute path of the G-Code file that Slic3r generates. All Slic3r configuration options are made available to the scripts by way of environment variables. These all begin with **SLIC3R_**. The following script would write out all Slic3r options to standard output:

```
#!/bin/sh
echo "Post-processing G-code file: $*"
env | grep ^SLIC3R
```

Figure 5.62: Example post-processing script to display Slic3r environment variables.

Example scripts can be found in the GitHub repository¹⁹.

Perl's in-place mode (`perl -i`) makes it easy to modify the contents of the G-Code file, without having to copy, edit, then replace the original. The following example will simply output the contents to standard output:

¹⁸ extttt<https://github.com/alexrxj/Slic3r/wiki/Writing-post-processing-scripts>

¹⁹ extttt<https://github.com/alexrxj/Slic3r/tree/master/utils/post-processing>

5.8. ADVANCED TOPICS

```
#!/usr/bin/perl -i
use strict;
use warnings;

while (<>) {
    # modify $_ here before printing
    print;
}
```

Figure 5.63: Example post-processing script to print each line to output.

5.9 Troubleshooting

Z Wobble

Undulations in the walls of a print may be due to wobble in the Z axis. A thorough analysis of the potential causes is given by whosawhatsis²⁰ in his article "Taxonomy of Z axis artifacts in extrusion-based 3d printing"²¹, however one point of particular interest for users of Slic3r is the wobble caused by motor steps not matching the pitch of the Z rods thread. This can be addressed by ensuring the `Layer Height` setting is a multiple of the full step length.

The relevant part of the above paper is quoted here:

To avoid Z ribbing, you should always choose a layer height that is a multiple of your full-step length. To calculate the full-step length for the screws you're using, take the pitch of your screws (I recommend M6, with a pitch of 1mm) and divide by the number of full-steps per rotation on your motors (usually 200). Microsteps are not reliably accurate enough, so ignore them for this calculation (though using microstepping will still make them smoother and quieter). For my recommended M6 screws, this comes out to 5 microns. It's 4 microns for the M5 screws used by the i3, and 6.25 microns for the M8 screws used by most other repraps. A layer height of 200 microns (.2mm), for example, will work with any of these because $200 = 6.25 * 32 = 5 * 40 = 4 * 50$.

²⁰ <http://goo.gl/iOYoK>

²¹ <http://goo.gl/ci9Gz>

5.10 Slic3r Support

Slic3r Support

A variety of resources are available to provide support for Slic3r.

Wiki and FAQ

The wiki provides up-to-date documentation, and a FAQ subsection which may help resolve any queries or issues.

- <https://github.com/alexrj/Slic3r/wiki/Documentation>
- <https://github.com/alexrj/Slic3r/wiki/FAQ>

Blog

Tips, hints and advice are published on the Slic3r blog.

- <http://slic3r.org/blog>

IRC

Found on the `irc.freenode.net` server, the following chat rooms are often filled with people who can provide real-time help:

- `#reprap`: Highly active community of the RepRap project with many users of Slic3r.
- `#slic3r`: Slic3r chat room where Slic3r developers and users can give help.

RepRap.org Forum

A dedicated forum for Slic3r exists in the RepRap forums.

- forums.reprap.org/list.php?263

Issue Tracker

If a bug may have been found in the software then an issue may be raised in the project issue tracker.

- github.com/alexrij/Slic3r/issues

Please take the time to read through the existing issues to see whether the problem has already been submitted. Also make sure that the problem is a bug in the application, support related questions should not be submitted.

If the bug appears to be unreported then please read the bug report guide before submitting: [extttthttps://github.com/alexrij/Slic3r/wiki/Quick-guide-to-writing-good-bug-reports](https://github.com/alexrij/Slic3r/wiki/Quick-guide-to-writing-good-bug-reports).

Printing with the Graphic LCD

The Graphic LCD allows you to print with the TAZ 3D printer without needing to have a computer connected or use host software such as Printron. This will allow for more efficient space in the workspace and free up a computer for other tasks.

In the following sections you will find general information on using the Graphic LCD, how to transfer .gcode files to the included sd card, heat up the printer, start a print, and make configuration adjustments.

6.1 GLCD Controller or Printron Host?

The Graphical LCD Controller is perfect for normal day to day printing and will be used in the majority of your print jobs. However, there are some instances where you will want to use Printron instead of the GLCD Controller. A few examples of when you would want to plug the USB cable back in and use Printron:

- When performing calibration checks a number of manual movements are required. Because of this it is easier and faster to make the required manual movements within Printron. Calibration checks can be done with the Graphic LCD, but require a number of repetitive menu selections.
- Printron offers a number of extra options for advanced users, including: custom gcode input, output display, and pronsole. Pronsole is the command line portion of Printron which can be used in scripts for automation or controlling a printer through remote access (SSH for example).

6.2 Multiple Connections

Because the TAZ 3D printer can be controlled by the Graphic LCD and by host software, caution is advised when connecting to the printer through USB. A general rule is: once you have started a print with either the Graphic LCD or Printron, for the rest of the print only use that controller. When printing with the Graphic LCD, never try to connect through USB in the Printron host software; wait until the print is complete, and then connect in Printron.

6.3 Putting Print Files On the SD Card

To print from the Graphic LCD you will need to transfer .gcode print files onto the SD card. Follow the normal steps, as explained in the Slic3r chapter, to create .gcode print files on your computer. Insert the SD card into your computer using a SD reader slot or USB SD card reader. Open a file browser / manager and locate the created .gcode files; drag and drop or paste the .gcode files to the SD card. Once the files have transferred, eject the SD card from your computer and insert it back into the SD card slot on the left side of the Graphic LCD case.

6.4 Printing with the Graphic LCD

The Graphic LCD Status Screen

After powering up your TAZ 3d printer the GLCD screen will turn on. After the start up screen you will see the Status screen (fig. 6.1, page 131). The Status screen is the default screen for the GLCD, presenting the current status of the printer. There are a number of live statuses shown on the

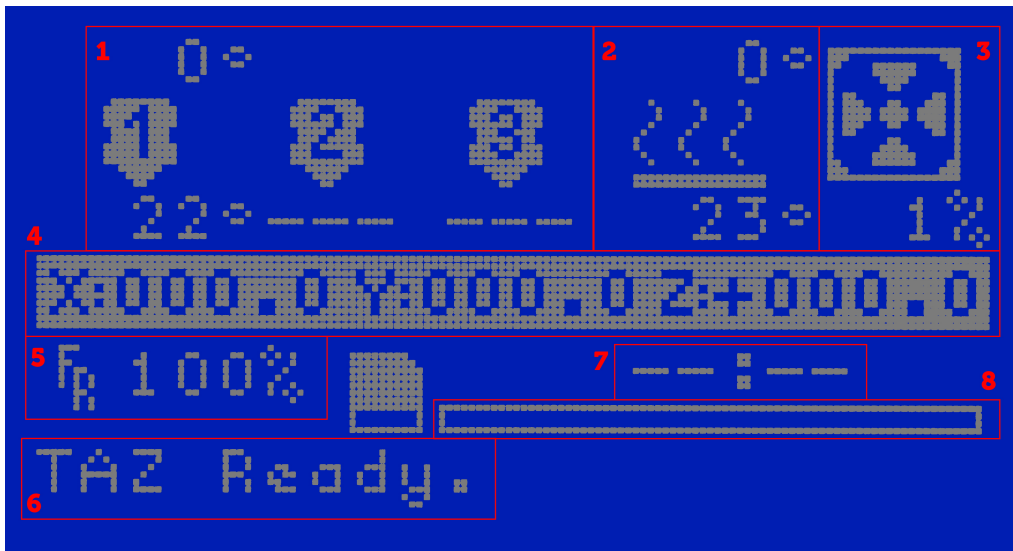

Figure 6.1: GLCD Info Screen

Status screen that will give you current temperatures, tool head coordinates, print status, and more. Shown in figure 6.1 above are the different numbered sections of the status screen. Follow the key below for more information on each section.

1. Hot end temperatures: represents the current temperature (bottom) and set temperature (top) of up to three nozzles.
2. Heat bed temperature: represents the current temperature (bottom) and set temperature (top) of the heat bed.
3. Fan speed: represents the current optional extruder fan speed. The fan is set to off (1%) by default as this function is not used by the TAZ printer. If you later modify your TAZ printer to use an extruder-mounted print-cooling fan, this status indicator will come in use. If cooling is turned on in Slic3r, this portion of the display will change to reflect the g-code embedded extruder fan control instructions.
4. Tool head coordinates: represents the current tool head coordinates on the X, Y, and Z axes.
5. Feed rate: represents the current feed rate setting. The feed rate is set to 100% by default which matches the speed set in the gcode generation. When on the status screen selection knob can be turned to increase or decrease the feed rate during the print. Increasing/decreasing the feed rate will increase/decrease the speed of the print.
6. Printer status: lists the current status of the printer including: SD card status, current printing file, or completed print time.
7. Current print time: lists the length of time for the current print job.
8. Progress bar: represents the progress of the current print job. When the bar is completely white the print is finished.

Using the Selection Knob

To navigate through the LCD menu use the selection knob by rotating to scroll through selections and pressing the knob to make a selection. From the main status screen, press the knob to move into the menu screen (fig. 6.2, page 133). To move backwards in the menu tree, select the top most menu selection on the current screen. Selections that will move you backwards through the menu tree are noted by an upwards facing arrow. Note that

6.4. PRINTING WITH THE GRAPHIC LCD

if the menu is left idle it will automatically move back to the main status screen.

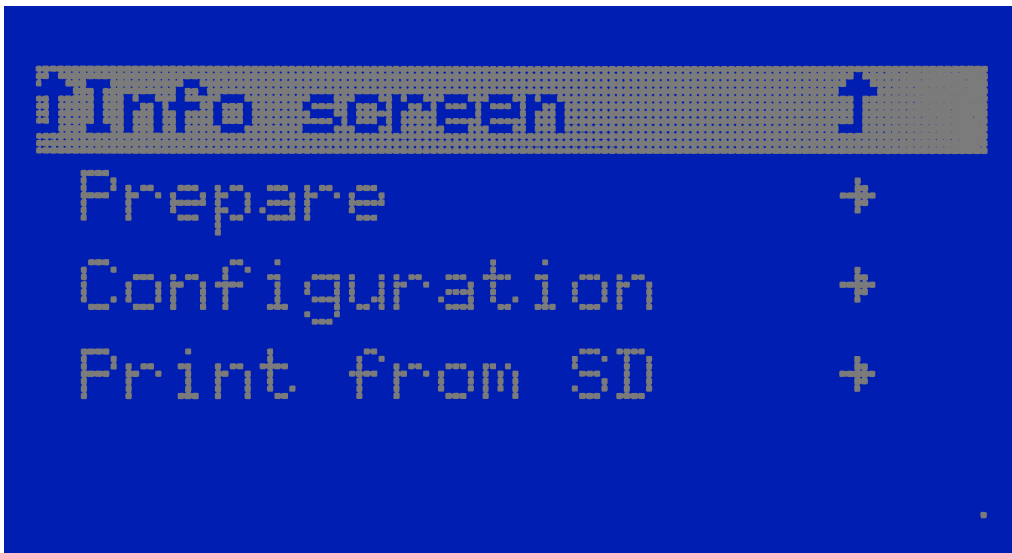

Figure 6.2: Main menu

Preparing for a Print

Before starting a print you will need to set the hot end and heat bed to the appropriate temperatures for the filament type you are using. To quickly set the printer to preheat, for ABS or PLA filament, click the selection knob to bring up the menu and select **Prepare**. Select **Preheat PLA** for PLA filament or **Preheat ABS** for ABS filament. This will set the temperatures for the hot end and heat bed and begin bringing the printer up to print-ready temperature.

If you need to set the extrusion and/or bed temperature to a different setting than the preheat temperature you can manually set the temperature. To do so, from the main menu navigate through: **Configuration** -> **Temperature** -> **Nozzle** or **Bed**. Clicking on either of these settings will give you a menu to set and select the desired temperature setting.

Selecting a File From the SD and Starting a Print

Once the hot end and heat bed have reached the desired temperature the printer is ready to print. From the main menu select the **Print from SD** option. You will now see a selection of the directories and .gcode files on the SD card. Navigate through the menu to locate the file you would like to print. Select the desired file to begin the print.

Making Manual Movements With the Graphic LCD

As noted previously (page 130), making numerous manual movements is easier done using the Printron host software. However, you can make manual movements with the GLCD. Navigate to Prepare -> Move Axis. You will then select the length of the movement and then the axis to move. Note, that only 1mm and 0.1mm movements are allowed for the Z axis and extruder.

When at the move screen turn the selection knob clockwise to move the axis in millimeters in the positive direction and counter-clockwise for the negative direction. Push the selection knob to complete the manual move.

Configuration Settings

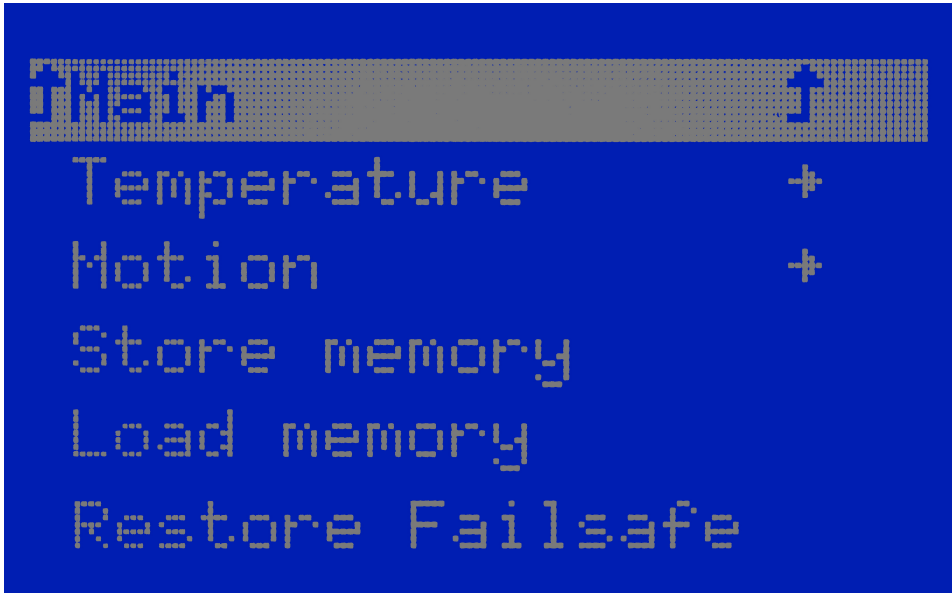

Figure 6.3: Configuration Menu

Out of the box, the TAZ 3D printer is already calibrated for printing. However, the GLCD does allow tuning of the more advanced configuration settings. It is highly suggested to not modify the configuration settings unless you are certain it is needed.

To find the configuration settings, navigate to the main menu and then Configuration (fig. 6.4, page 136). In the configuration settings you will find temperature and motion settings. These settings include default temperature settings, axis steps per mm, and more.

The **Store Memory** and **Load Memory** functions will store and load the changes you make using the GLCD Controller. You must use the **Store Memory** function to save the adjusted settings when the printer is powered down. The stored settings will then automatically load when the printer is repowered. If you ever need to revert back to the factory settings navigate to Configuration -> Restore Failsafe. Clicking Restore Failsafe will set all configuration settings back to the original factory settings in the firmware.

For more information on the configuration settings please see the TAZ support page on LulzBot.com.

GLCD Controller Menu Diagram

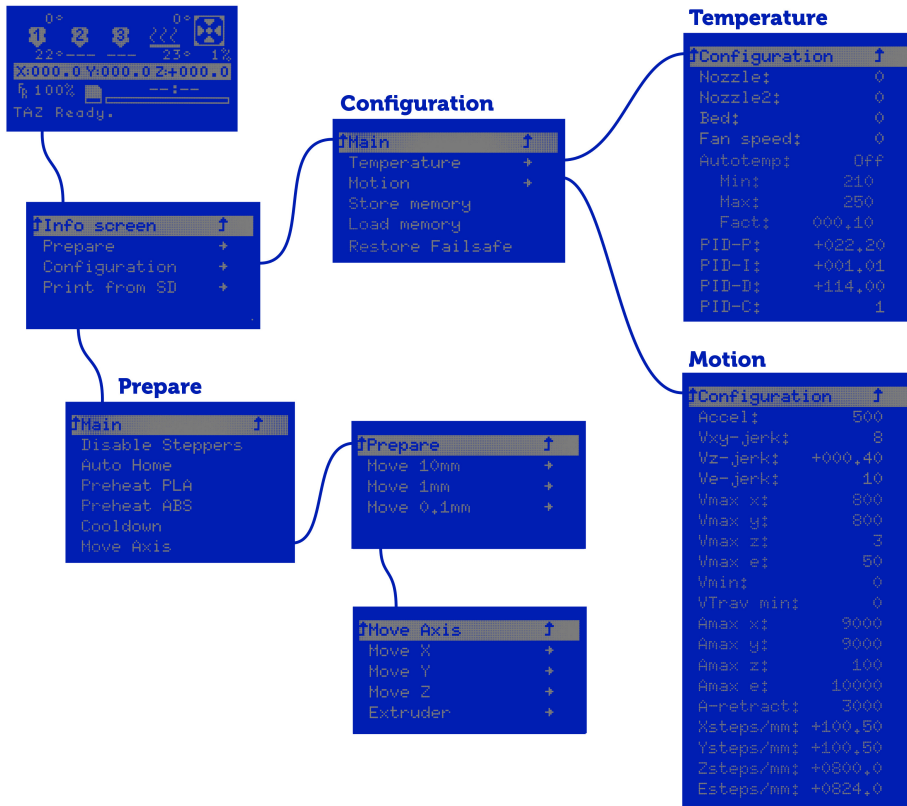

Figure 6.4: Configuration Menu

Maintaining Your 3D Printer

7.1 Overview

There is little maintenance needed in keeping your TAZ 3D printer running. Depending on your rate of use you will want to perform a quick check of your printer every 2-4 weeks. The following maintenance guide lines will keep your printer printing quality parts.

7.2 Smooth Rods

Wipe the smooth steel rods with a clean rag or paper towel. The linear bushings leave a solid lubricant that builds up over time. If you begin hearing squeaking noises while the printer is printing, this is likely a sign that the smooth rods need to be cleaned. NOTE: never apply any lubricant or cleaning agent to the smooth rods; the bushings are self lubricating.

7.3 Threaded Rods

Periodically, you will want to wipe down the threaded rods with silicone based grease. Never use any petroleum based grease, as it may compromise the plastic parts. Apply the silicone grease both above and below the X ends on the threaded rods and wipe down the threaded rods. Use pronterface to drive the Z axis up and down to help further distribute the lubricant.

7.4 PET Sheets

After repeated use, the PET sheet print surface will begin to wear. Replacement PET sheets are available on LulzBot.com. To replace the PET print surface, peel off the worn PET sheet from the glass print surface. If there is any glue or plastic residue left on the glass surface, clean it with acetone or an alcohol based glass cleaner. Peel a corner of the clear plastic away from the green PET sheet and apply the corner of the PET to the corner of the glass. Align the PET sheet onto the glass. Using a paper towel begin slowly smoothing/applying the PET onto the glass while pulling back the clear sheet from underneath the PET. You can also spray glass cleaner onto the paper towel or the top side of the PET for a smoother application.

7.5. HOBBED BOLT

After applying the PET sheet to the glass any bubbles can be pushed out or smoothed down using a credit card or stiff and dull piece of plastic.

7.5 Hobbed Bolt

The plastic filament is pulled through the extruder by a hobbed bolt. After repeated use, the teeth of the hobbed bolt can become filled with plastic. Using the brush or pick from the printer kit, clean out the hobbed bolt teeth. If an extruder jam ever occurs, remove the plastic filament from the extruder and clean out the hobbed bolt.

7.6 Software

Every quarter LulzBot will release a new stable version of the software. It is best to update the software every time a new version is released. The software is as important in printing quality parts as the hardware. Each quarterly software update can bring advances in print quality. The files are available at <http://download.lulzbot.com/TAZ/> . You can also find updated software versions in the Support/Downloads section of LulzBot.com.

7.7 Belts

Over long periods or after extensive relocating of the printer you may need to re-tighten the belts on the TAZ 3D printer. For the X axis, using the 2.5mm hex driver, loosen one of the belt clamps. The belts clamps are located on the X axis carriage. To loosen the belt clamp, loosen the M3 screws on the clamp. Using the needle nose pliers, pull the belt tight. While holding the belt tight, tighten down the M3 screw. The Y axis belt can be tightened in the same steps as the X axis with the belt clamps found on the bottom of the Y axis plate. Make sure not to over tighten the belts as this can cause unneeded stress on the printer.

7.8 Hot End

The hot end should be kept clean of extruded plastic by removing melted plastic strands with the tweezers. If melted plastic builds up on the hot end nozzle it can be cleaned with a paper towel soaked with acetone. Make sure the hot end is completely cool before attempting to clean the nozzle with acetone.

7.9 Electronics

The electronics case holding the RAMBo board may need to have dust blown out occasionally. Power down the printer and use the provided 2.5MM driver to remove the 4 M3 screws holding the lid to the enclosure. **The fan is mounted to the lid and connected to the RAMBo board. Be careful with the fan cable during removal.** Once removed use short bursts of compressed air to blow out any dust or debris. Plug in the lid fan paying attention to polarity and reattach the lid.

Advanced Usage

8.1 Intro

After becoming familiar with printing with the TAZ 3D printer with the default settings there are a few advanced techniques that may help in getting better and more consistent prints. Some of these instructions include items and materials not included with the TAZ. With any of these additional items or materials, follow safety and usage guidelines as instructed by the manufacturer.

8.2 Changing nozzles

The TAZ 3D printer ships with a standard 0.35mm nozzle which allows small layer resolution and up to 0.35mm layers. Although the 0.35mm nozzle will be perfect for most printing applications LulzBot also offers smaller and larger nozzle sizes.

In most cases the nozzle is best changed when the hot end is slightly warm. NEVER try to remove the nozzle when the hot end is at extrusion temperature. At higher temperatures the threaded extension expands in the nozzle causing the nozzle to bind if turned. Heat the hot end to 160°C. This will soften the plastic inside the hot end and allow the nozzle to be loosened off the threaded extension. Power off the printer and continue unscrewing the nozzle once cooler. Take care when removing the nozzle while the hot end is hot. Wear leather gloves or use a towel to turn the nozzle off of the hot end.

To change the nozzle you will need an 18mm and 13mm wrench. Slide the 18mm wrench onto the rectangular aluminum heater block away from the heater resistor and thermistor wires.

Using the 13mm wrench turn the nozzle counter clock-wise. Make sure the nozzle is turning off of the threaded aluminum extension that runs up through the heater block. Do not allow the heater block to turn. This can put strain on and possibly damage the wiring.

Once you have removed the nozzle you can then thread on the other nozzle size you would like to use. Make sure the nozzle has threaded correctly onto the threaded extension before trying to turn it with the wrench. Turn the nozzle clock-wise until it tightens against the heater block.

8.3. ABS/ACETONE GLUE

After installing the new nozzle you may need to adjust your Z home trigger setting before printing again. Refer to the Printing Your First Print section (page 47) for calibrating the Z home trigger setting.

If you will be changing nozzles frequently we suggest reapplying a small amount of high temperate anti-seize to the inside threads of the nozzles. You will need an anti-seize capable of temperature of at least 250°C.

8.3 ABS/Acetone Glue

Acetone is not included or required with the TAZ 3D printer. An acetone safety label is included for the HDPE bottle.

Acetone can cause skin irritation when prolonged skin contact occurs. It is recommended to use acetone safe gloves when applying the ABS/acetone glue. Use the ABS/acetone glue in a well ventilated space. Leave the mixture bottle closed except when applying a small amount to the wiping towel. Acetone liquid and vapors are highly flammable. Keep acetone away from open flames and high temperature sources, including the 3D printer. Read the warnings label on your purchased acetone packaging for additional warnings.

You may find that during printing, printed parts lift off of the print surface on the corners. If you are seeing this problem you can make an ABS/acetone glue to apply to the print surface. Using the HDPE acetone safe bottle included in the printer kit, fill the bottle 3/4 full with acetone. Now cut eight, 75mm lengths of ABS filament and put them in the bottle with the acetone. Allow the ABS filament to dissolve for 2 hours.

To apply the acetone/ABS mixture put a small amount onto a paper towel. Now, rub the towel onto the cool PET print surface to apply a *thin* layer of ABS. Generally only one thin layer of the acetone/ABS solution is needed. However, if needed you can apply multiple coats.

8.4 Using 1.75mm Filament

This procedure is highly advanced and involves disassembling parts of the printer, including the hot end. We recommend using 3mm plastic filament as we have yet to see major advantages to using 1.75mm filament. If you would still like to use 1.75mm filament make sure to follow the instructions

carefully. If the instructions are not followed correctly you will run the risk of damaging the printer.

The TAZ 3D printer is set up to use 3mm plastic filament by default. Although we recommend using 3mm filament, the TAZ is also capable of printing 1.75mm filament. To print with 1.75mm filament you will need to change the PTFE tube inside the Budaschnozzle hot end. Purchase the 1.75mm conversion PTFE tube in our store at www.LulzBot.com.

To change out the PTFE tube:

1. Remove the plastic filament from the extruder if there is any currently loaded by bringing the hot end up to extrusion temp and backing out the filament in Printron
2. Using the Printron manual controls, raise the Z axis to 100mm.
3. Turn off all power to the printer and allow the hot end to cool. Disconnect the two 4 pin connectors on the extruder assembly. Locate and remove, with the 2.5mm hex driver, the tool head 3mm screw in top center of the X axis carriage. Remove the extruder mount from the X axis carriage.
4. Using a 3mm hex driver loosen and remove the two 4mm screws from the bottom of the extruder X axis carriage. This will allow you to lift the extruder body and hot end off of the extruder mount. Set the extruder body aside.
5. The hot end now has to be partially disassembled to replace the PTFE tube for 1.75mm filament.
6. Using the 2.5mm hex driver, remove the three 3mm screws from the bottom plate of the hot end. Remove the aluminum mount plate.
7. Note the path of the wires through the three strain relief slots in the wooden top plate. Gently remove the wires from the strain relief slots. Remove the top wooden plate.
8. With the top wooden plate removed the white PTFE tube should now be visible. The PTFE tube is set through a number of aluminum and PTFE washers. Remove the washers and PTFE tube from the hot end.
9. The PTFE can generally be pushed out of the washers by hand. Although, you may need to use the 4mm hex driver to push the PTFE tube through and out of the washers. Place aside the PTFE tube for 3mm filament.

8.4. USING 1.75MM FILAMENT

10. Push the PTFE tube for 1.75mm filament through the washers in the original pattern. The PTFE tube should be approximately centered in the heat sink washers with equal links of the PTFE tube sticking out of the heat sink.
11. Replace the heat sink and PTFE tube back into the hot end. Lightly push down on the PTFE tube to make sure it is completely set into the hot end.
12. Replace the top wooden plate. Make sure to line up the strain relief slots on the side of the wires.
13. Place the aluminum mount bracket on top. Screw in and lightly tighten the three 3mm screws from the bottom plate. **Do not over-tighten these screws as you can crack the wooden plate.**
14. Wrap the wires through the strain relief slots in the correct path of all four wires, snaking through each slot together.
15. Place the hot end back down into the extruder mount. Make sure the wires are facing the rear of the printer
16. Place the extruder body back on top of the hot end and extruder mount. Line up the two mounting holes. Push the two 4mm screws through the bottom of the X carriage, through the hot end, and into the extruder body. Thread the screws using the 3mm hex driver but leave loose for now.
17. Reconnect the two four pin connectors.
18. Finally, push 1.75mm filament through the extruder and into the hot end. This will align the filament travel space. Tighten the two 4mm screws from the bottom of the X axis carriage.

Before printing with 1.75mm filament, make sure to make the needed changes in Slic3r (found at **Filament Settings > Filament > Diameter**) for 1.75mm filament. You will need to re-slice any previously sliced files with the new settings for 1.75mm filament.

Hardware and Software Source Code

The LulzBot™ TAZ 3D printer is a free/libre hardware design. All of the source files are available at <http://download.lulzbot.com/TAZ> including:

- The latest version of this document, with L^AT_EX source code.
- 3D models and print files for all of the printed parts in `.stl`, `.gcode`, and other original source files.
- 3D calibration objects and random novelties.
- Production file for calculating large print runs.
- Design files for all electronics and machined parts.
 - Budaschnozzle hot end
 - RAMBo electronics
 - Various spec sheets
- Bill of materials including every part needed to build the printer.
 - TAZ
 - Budaschnozzle
- Drawings of components.
 - Aluminum extrusions
 - Budaschnozzle
 - Bed plate
- Software binaries and source code for GNU/Linux and others. Also includes known good configuration files.
 - Slic3r
 - Printron
 - Marlin

3D Printer Support

10.1 LulzBot

For common technical support questions for your TAZ 3D printer please visit lulzbot.com/support. Also, visit forum.lulzbot.com for support and tips from the LulzBot community. If you have further questions, e-mail our support team at support@lulzbot.com. Please completely read this manual before contacting for support questions or help. The latest version of this information guide is also available at <http://download.lulzbot.com>. You can also find more information including images, videos, and updated versions of this manual in the Support section of LulzBot.com.

10.2 Community

Community Support and Resources

- LulzBot forum: forum.lulzbot.com
- IRC chat rooms on the irc.freenode.net server.
 - **#reprap**: Highly active community chat room where help can easily be found
 - **#slic3r**: Slic3r chat room where Slic3r developers and users can give help
- RepRap.org forums: forums.reprap.org

Contact Information

11.1 Support

Email: support@LulzBot.com

Phone: +1-970-377-1111 x610

11.2 Sales

Email: sales@LulzBot.com

Phone: +1-970-377-1111 x600

11.3 Websites

Aleph Objects, Inc., the makers of LulzBot 3D Printers:

www.AlephObjects.com

LulzBot 3D Printers and parts:

www.LulzBot.com

forum.LulzBot.com

INDEX

Symbols

1.75mm filament, 143

A

ABS, 143

acetone, 138, 140, 143

advanced techniques, 142

aluminum extrusions, 148

AMF, 72

anti-seize, 143

Apple OS X, 38, 45

B

baud rate, 41

bed leveling, 48

bed plate, 148

belts, 139

bill of materials, 148

binaries, 59

Blender, 45

blog, 127

bottle, 143

Budaschnozzle, 148

burns, xii

bushings, 138

C

CAD, 45

calibration, 60, 148

command line, 119

community support, 127, 150

configuration

export, 114

import, 114

Configuration Wizard, 62

connecting, 41

cooling, 97

fans, 98

slowing down, 98

D

download, 38, 59, 139, 148

driver, 38

E

electronics, xii, 140, 148

electronics receptacles, 26

end stop, 48

end stops, 30, 44

extruder, xii, 38

extruder jam, 139

extruders

multiple, 103

extrusion, 38

extrusion width, 108

F

fan, 140

feed tube, 36

filament, 52

Filament Settings, 82

- Cooling
 - Bridges fan speed, 99
 - Disable fan for first n layers, 99
 - Enable fan if print time is below t seconds, 99
 - Fan speed, 99
 - Keep fan always on, 99
 - Min print speed, 100
 - Slow down if layer print time is below t seconds, 99
- Filament, 83
 - Diameter, 66, 83
 - Extrusion multiplier, 83
 - Temperature
 - Bed, 68, 83
 - Extruder, 67, 83

filament spool, 34

First Layer, 70

forums, 127, 150

FreeCAD, 45, 116

Freenode, 127, 150

G

gcode, 38, 148

GitHub, 59

glass, 138

GNU/Linux, 38, 45

grease, 138

H

hardware, 148

hazards, xii

heater block, xii, 142

high resolution, 142

hobbed bolt, 139

hot end, 52, 140, 142

I

infill, 89, 93

IRC, 127, 150

L

latex, 148

layer height, 109

license, 59

lubricant, 138

M

maintenance, 138

Marlin, 148

Menu

- Combine multi-material STL files..., 107

models, 72

- finding, 72

N

novelties, 148

nozzle, 142

O

OBJ, 72

ooze, 94

OpenSCAD, 45

operating system, 38

P

PET sheet, 138, 143

Plater, 73, 105

plater, 38

port, 41

post processing, 124

power supply, xii, 26

Print Settings, 77

- Brim, 82

- Brim width, 82

INDEX

- Infill, 80
 - Fill angle, 93
 - Fill density, 80, 89
 - Fill pattern, 80, 89
 - Fill Top/bottom fill pattern, 89
 - Infill before perimeters, 93
 - Infill every n layers, 93
 - Only infill where needed, 93
 - Only retract when crossing perimeters, 93, 95
 - Solid infill every n layers, 93
 - Solid infill threshold area, 93
 - Layer height, 78
 - Multiple Extruders, 105
 - Output options
 - Post-processing scripts, 124
 - Perimeters, 79
 - Sequential printing
 - Extruder clearance, 117
 - Skirt and brim
 - Skirt, 96
 - Solid layers, 79
 - Speed, 81, 87
 - Acceleration control, 88
 - Bridges, 87
 - External perimeters, 87
 - First layer speed, 87
 - Gap fill, 87
 - Infill, 81, 87
 - Perimeters, 81, 87
 - Small perimeters, 87
 - Solid infill, 87
 - Support material, 87
 - Top solid , 87
 - Travel, 81, 87
 - Support material, 81
 - Enforce support, 100
 - Generate support material, 81, 100
 - Overhang threshold, 100
 - Pattern, 101
 - Pattern Angle, 102
 - Pattern Spacing, 102
 - Pattern spacing, 81
 - Raft layers, 81
 - printed parts, 148
 - Printer Settings, 83
 - Custom G-code
 - End G-code, 85
 - Start G-code, 85
 - Tool change G-code, 106
 - Extruder
 - Extruder offset, 104
 - Nozzle diameter, 65, 85
 - Firmware
 - G-code flavour, 63, 85
 - Size and coordinates, 84
 - Bed size, 64, 84
 - Print center, 84
 - Z offset, 84
 - Printing, 77
 - Printrun, 41, 148
 - printrun, 38, 40
 - profiles, 114
 - create, 114
 - delete, 115
 - pronsole, 38
 - pronterface, 38
 - PTFE tube, 29, 143
- R**
- RAMBo, 29, 140, 148
 - RepRap, 127, 150
 - retraction, 94

INDEX

S

scripting, 119
scripts, 124
SD card, 38
Sequential Printing, 117
Shapesmith, 46
simple mode, 77
skirt, 96
Slic3r, 148
smooth rods, 138
software, 38, 45, 139, 148
Source Code, 59
source code, 148
speed, 86
spool, 34
static, xiii
STL, 45, 72, 148
 cleaning, 76
stl, 38
support material, 100

T

technical support, 150
temperature, xii, 38, 51, 97
threaded extension, 142
threaded rods, 138

U

USB cable, 26, 41

W

warnings, xii
warping, 143
website, 127
Windows, 38, 45
windows, 39
wing nuts, 34
wires, xii
wrench, 142

Z

z axis, 49
Z Wobble, 126

GLOSSARY

.gcode *The file extension for G-Code files*

3D Printer *Also referred to as additive manufacturing, is the process of fabricating objects from 3D model data, through the deposition of a material in accumulative layers.*

ABS *Acrylonitrile Butadiene Styrene thermoplastic. Usually extrudes at 230C.*

Acetone *A colorless, volatile, flammable liquid ketone, (CH₃)₂CO, used as a solvent for ABS.*

Baud Rate *Refers to the speed at which the host controller communicates with the 3d Printer electronics.*

CAD *Computer Aided Design*

End stops *Mechanical or optical switches that are used to mark the 3 home (zero) positions.*

Filament *Plastic material in string like form, as is fed to the printer.*

free/libre *Free/Libre hardware and software can be thought of as free as in free speech, not just free as in free beer, although most free/libre software is available for no cost. Libre hardware designs can be copied, modified and are usually available for download. Free/Libre software can be used in a similar fashion.*

GCODE *The common name for the most widely used CNC programming language.*

HDPE *High Density Polyethylene.*

Heater block *Machined from Aluminium, the heater block generates heat with a heater resistor and uses a thermistor to measure the temperature.*

GLOSSARY

Heater resistor *A special type of resistor that is used to apply heat in a small area.*

HIPS *High Impact Polystyrene.*

Hot end *The hot end is the whole part where the plastic melts, including the nozzle, heater block, thermistor, and heat sink. The Budaschnozzle is LulzBot's™ hot end.*

Idler *Refers to parts using a bearing (usually a 608ZZ) to add tension in belts or to add pressure against a rolling surface.*

Layer height *The thickness of each individual deposited layer of the three dimensional model when cut with a slicing program.*

Laywoo-D3 *Wooden filament similar to PLA. Contains 40 percent recycled wood. Usually prints at 180C- 210C. Color can be changed by varying the extrusion temperature.*

Nozzle *The metal tip at the bottom of the hot end. It has a small hole where the plastic filament comes out of the printer.*

PEEK *Polyether ether ketone- an organic polymer used to insulate the hot end due to it's mechanical properties at elevated temperatures.*

PET *Polyethylene terephthalate.*

PLA *Polylactic Acid is a corn-based biodegradable polymer. Usually extrudes at 185C.*

Polycarbonate *A strong and impact resistant thermoplastic. Usually extrudes at 300C.*

PTFE *Polytetrafluoroethylene is a synthetic fluoropolymer used in the Budaschnozzle for it's low coefficient of friction.*

RAMBo *[R]epRap [A]]duino-[M]ega compatible [M]other [Bo]ard. Designed by Joynnyr of Ultimachine.*

Spool *Plastic Filament coiled and stored on a plastic reel. Preferred due to improved feeding and better mounting options.*

Thermistor *A special type of resistor that changes resistance based on temperature. It is used to measure temperature on the nozzle and the heated bed.*

Threaded extension *Used to separate the heater block and nozzle from the PEEK insulator. The plastic filament passes through the threaded extension into the melting chamber.*

Colophon

Created with 100% Free/Libre Software

GNU/Linux

L^AT_EX Memoir
