

LULZBOT TAZ USER MANUAL



LULZBOT™
Aleph Objects, Inc.

LulzBot™ TAZ User Manual

by Aleph Objects, Inc.

Copyright © 2013 Aleph Objects, Inc.

Permission is granted to copy, distribute and/or modify this document under the terms of the Creative Commons Attribution-ShareAlike 3.0 Unported license (CC BY-SA 3.0).

Published by Aleph Objects, Inc., 123 SW 12th Street, Loveland, Colorado, 80537 USA.

For more information, call +1-970-377-1111 or go to www.LulzBot.com and www.AlephObjects.com.

ISBN: 978-0-9893784-1-3

20130729

Contents

WARNINGS

Safety Information	ix
Read Me First!	x
Hazards and Warnings	x
1 Setup Your Printer	13
2 3D Printer Software	27
2.1 Software Overview	28
2.2 Drivers	28
2.3 Slic3r	28
2.4 Printron	30
2.5 CAD and 3D Modeling Software	35
3 Slic3r in Depth	37
3.1 Intro	38
3.2 Getting Slic3r	38
3.3 First Slice	40
3.4 Expert Mode	66
3.5 Configuration Organization	82
3.6 The Cutting Edge of Slicer	84
4 Loading Print Material	87
5 Your First 3D Print	91
5.1 Set Temperature	92
5.2 Inserting Filament Into the Extruder	92
5.3 Home Printer	93
5.4 Z Print Height	95
5.5 Remove Part	96
6 Maintaining Your 3D Printer	97

CONTENTS

6.1	Overview	98
6.2	Smooth Rods	98
6.3	PET Sheets	98
6.4	Hobbed Bolt	99
6.5	Software	99
6.6	Belts	99
6.7	Hot End	100
6.8	Electronics	100
7	<i>Advanced Usage</i>	101
7.1	Intro	102
7.2	Changing nozzles	102
7.3	ABS/Acetone Glue	103
8	<i>Hardware and Software Source Code</i>	105
9	<i>3D Printer Support</i>	107
9.1	LulzBot	108
9.2	Community	108
10	<i>Contact Information</i>	109
10.1	Support	110
10.2	Sales	110
10.3	Websites	110
Index	111
Glossary	115

List of Figures

1.1	Locate the four Y axis bolts	14
1.2	Remove the four Y axis bolts	15
1.3	Locate the four Y axis mounts on the frame	16
1.4	Screw in and tighten the four Y axis bolts	16
1.5	Connect the two connectors found at the rear of the Y axis . .	17
1.6	Connect the two connectors on the left of the print bed	18
1.7	Locate the two zip ties found in the bag with the manual . . .	18
1.8	Tightly wrap the zip ties around the bed wires and through the strain relief slot	19
1.9	Power supply and USB receptacles	20
1.10	Power supply	21
1.11	12V DC Power supply plug and receptacle	21
1.12	The power supply plug correctly plugged in	22
1.13	Filament Guide	23
1.14	Filament Guide Setting	23
1.15	Axes movement directions	24
1.16	End stop locations	25
2.1	Slic3r application, STL to Gcode generator	29
2.2	Printrun application for 3D printer control	31
2.3	Printrun controls	32
2.4	Printrun viewer	34
3.1	Configuration Wizard: Welcome Screen	41
3.2	Configuration Wizard: Firmware Type	42
3.3	Configuration Wizard: Bed Size	43
3.4	Configuration Wizard: Nozzle Diameter	44
3.5	Configuration Wizard: Filament Diameter	45
3.6	Configuration Wizard: Extrusion Temperature	46
3.7	Configuration Wizard: Bed Temperature	47
3.8	Configuration Wizard: End	48
3.9	Simple Mode: Print Settings.	51
3.10	Creating a vase from a solid model.	52
3.11	An example of support material.	53

List of Figures

3.12	An example of brim.	54
3.13	Simple Mode: Filament Settings.	55
3.14	Simple Mode: Printer Settings.	57
3.15	Shapesmith online CAD tool.	61
3.16	Plater	62
3.17	Minimug model.	63
3.18	STL file loaded.	63
3.19	FreeCAD part repair.	65
3.20	Expert mode speed options.	67
3.21	Infill pattern settings.	69
3.22	Infill pattern: Line (344.51mm / 5m:20s)	69
3.23	Infill pattern: Rectilinear (350.57mm / 5m:23s)	69
3.24	Infill pattern: Concentric (351.80mm / 5m:30s)	70
3.25	Infill pattern: Honeycomb (362.73mm / 5m:39s)	70
3.26	Infill pattern: Hilbert Curve (332.82mm / 5m:28s)	70
3.27	Infill pattern: Archimedean Chords (333.66mm / 5m:27s)	70
3.28	Infill pattern: Octagram Spiral (318.63mm / 5m:15s)	71
3.29	Infill pattern comparison in a complex object. Left to Right: honeycomb, line	71
3.30	Infill patterns at varying densities. Left to Right: 20%,40%,60%,80%. Top to Bottom: Honeycomb, Concentric, Line, Rectilinear, Hilbert Curve, Archimedean Chords, Octagram Spiral	72
3.31	Infill advanced settings.	73
3.32	Retraction settings.	74
3.33	Skirt settings.	76
3.34	Cooling strategy.	77
3.35	Cooling advanced settings.	79
3.36	Support structure options.	80
3.37	Minimug model, tilted 45°.	81
3.38	Support infill pattern: Rectilinear	81
3.39	Support infill pattern: Rectilinear Grid	81
3.40	Support infill pattern: Honeycomb	82
3.41	Example of pattern angle rotated 45°.	82
3.42	Saving a profile.	84
3.43	Deleting a profile.	84
4.1	Filament spool mount parts	88

LIST OF FIGURES

4.2	Filament spool mount front	89
4.3	Filament spool mount back	89
4.4	Filament run through the guide	90
5.1	Extruder idler release	92
5.2	Extruder filament slot	93
5.3	Nozzle height	94
5.4	Z end stop trigger	94
5.5	First layer adhesion	95

WARNINGS
SAFETY INFORMATION

Read Me First!

READ THIS MANUAL COMPLETELY BEFORE UNPACKING AND POWERING UP YOUR PRINTER.

Hazards and Warnings

The TAZ 3D printer has motorized and heated parts. When the printer is in operation always be aware of possible hazards.

Electric Shock Hazard

Never open the electronics case when the printer is powered on. Before removing the electronics case cover always power down the printer and completely turn off and unplug the power supply and allow the power supply to discharge for at least 1 minute.

Burn Hazard

Never touch the extruder nozzle or heater block without first turning off the hot end and allowing it to completely cool down. The hot end can take up to twenty minutes to completely cool. Also, never touch recently extruded plastic. The plastic can stick to your skin and cause burns. Also beware of the heated bed which can reach high temperatures capable of causing burns.

Fire Hazard

Never place flammable materials or liquids on or near the printer when powered or in operation. Liquid acetone and vapours are extremely flammable.

Pinch Hazard

When the printer is in operation take care to never put your fingers in the moving parts including the belts, pulleys, or gears. Also, tie back long hair or clothing that can get caught in the moving parts of the printer.

HAZARDS AND WARNINGS

Static Charge

Make sure to ground yourself before touching the printer, especially the electronics. Electrostatic charge can damage electronic components. To ground yourself touch a grounded source.

Age Warning

For users under the age of 18, adult supervision is recommended. Beware of choking hazards around small children.

Setup Your Printer

Setup Your Printer

Locate the unpacking document and follow the steps to unpack your printer before you move on to the Setup steps.

1. Your printer has been pre-calibrated and tested; however, after unpacking all of the components you will need to re-mount the Y axis onto the frame and connect the bed and Y axis connectors. Please follow the steps completely to make certain that the Y axis is re-mounted correctly and you will be on your way to your first print.
2. Place the TAZ frame and Y axis assembly on a flat and level surface. Bring your attention to the Y axis assembly and find the four Y axis bolts. The four bolts, located on the Y axis aluminum frame bars, have large plastic knobs that allow the bolts to be easily turned by hand (Fig. 1.1, page 14). Turning counter clock-wise, remove each of the four Y axis bolts and set aside (Fig. 1.2, page 15).

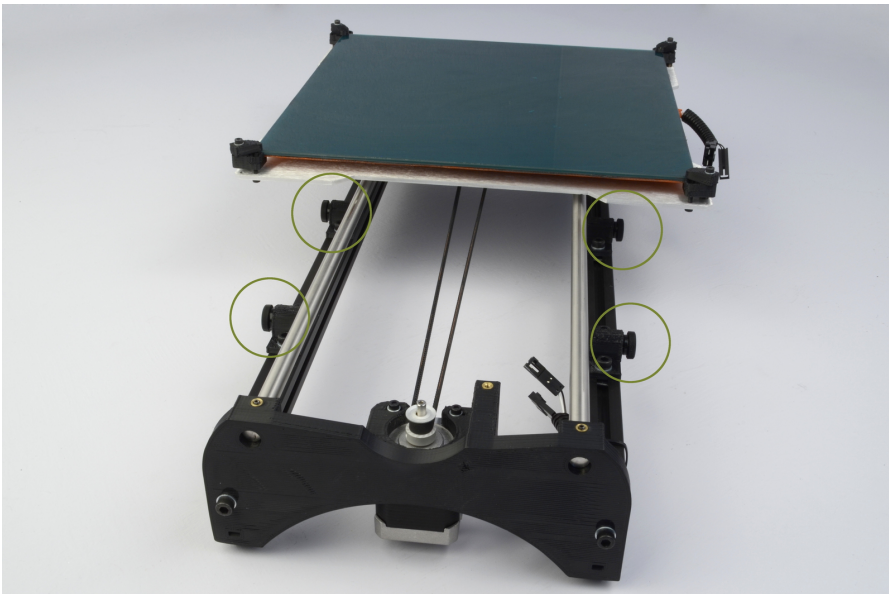

Figure 1.1: Locate the four Y axis bolts



Figure 1.2: Remove the four Y axis bolts

3. On the TAZ frame locate the four Y axis mount brackets shown in Fig. 1.3 (pg. 16). With the print surface facing up and the stepper motor end of the Y axis facing back, slide the Y axis assembly in between the Y axis mount brackets. The four Y axis mount brackets will line up with the Y axis bolt holes on the Y axis assembly. Thread the four Y axis bolts through the brackets, into the Y axis assembly (Fig. 1.4, page 16). Before completely tightening the Y axis bolts make sure the Y axis aluminum bars are pushed down against the TAZ frame lower bars. You can do this by slightly tilting the printer, on the side edge, enough to lift the feet of the Y axis off of the table. The weight of the Y axis will seat it against the TAZ frame. While the printer is slightly tilted tighten the four Y axis bolts. The printer can be now be set flat on the table.

Setup Your Printer

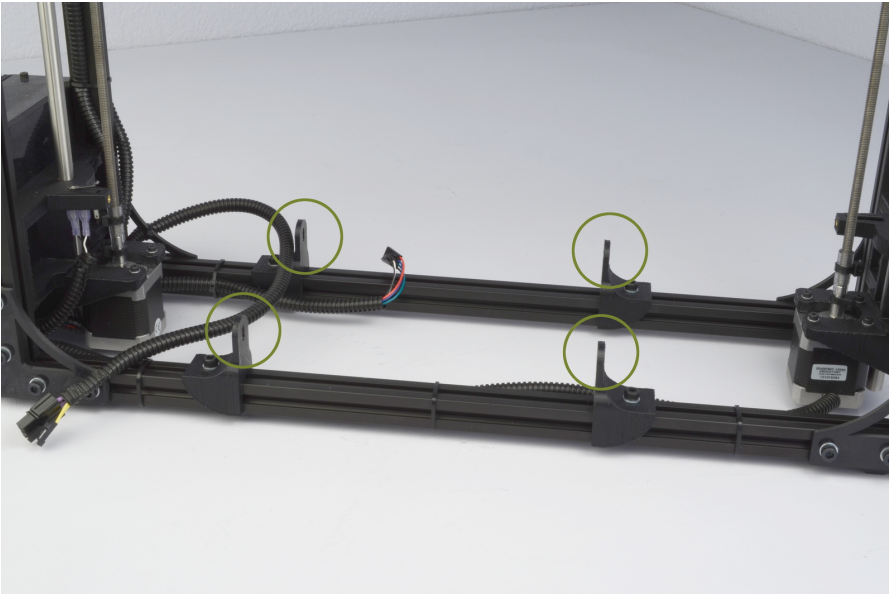

Figure 1.3: Locate the four Y axis mounts on the frame

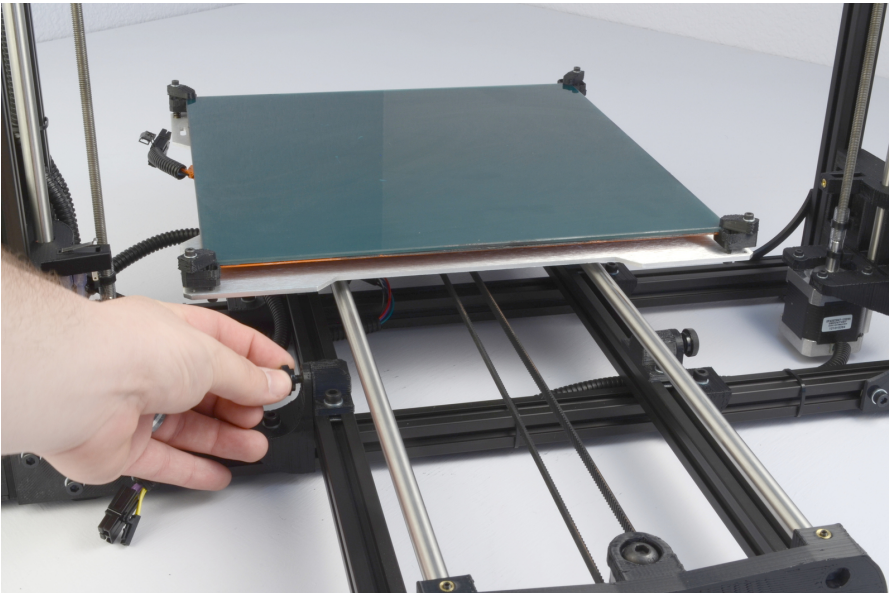

Figure 1.4: Screw in and tighten the four Y axis bolts

4. The final step of installing the Y axis is connecting the print surface connectors and Y axis connectors. Pull the print bed completely to the front of the printer to get access to the Y axis connectors. You will find matching male and female 4 pin stepper motor connectors and two pin end stop connectors. Connect the matching male and female connectors (Fig. 1.5, page 17); make sure the connector lock clicks to be sure that the connection is secure.

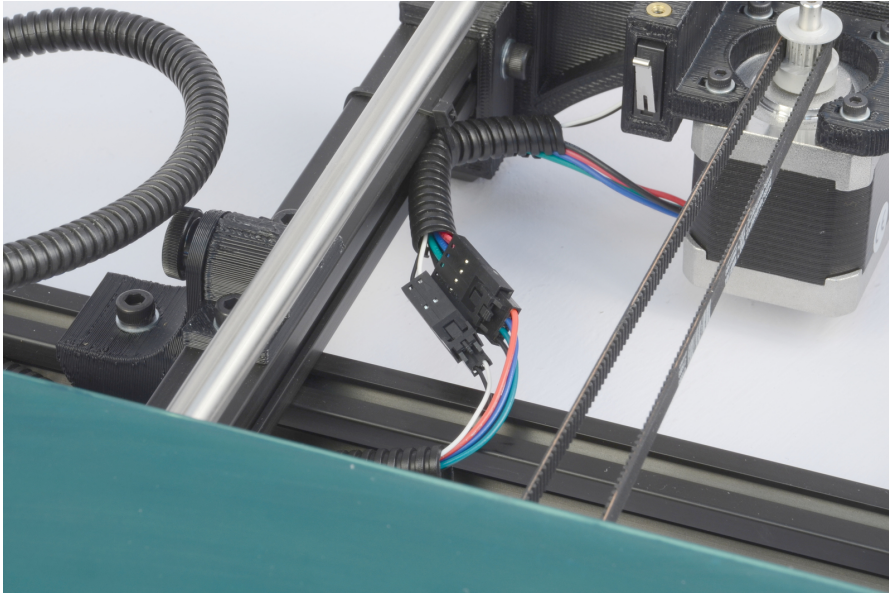

Figure 1.5: Connect the two connectors found at the rear of the Y axis

5. Locate the two connectors to the left of the print bed. Connect the matching female and male large two pin heat bed connectors and the small two pin connectors (Fig. 1.6, page 18).
6. Locate the two small black zip ties that are included in the documents bag (Fig. 1.7, page 18). Wrap the two zip ties through the slot, located on the left rear of the aluminum bed plate, and around the print bed wires (Fig. 1.8, page 19). Tighten the zip ties snug so the wire cannot move freely. Cut off the excess end of the zip ties with the needle nose pliers included in the tool bag.



Figure 1.6: Connect the two connectors on the left of the print bed



Figure 1.7: Locate the two zip ties found in the bag with the manual

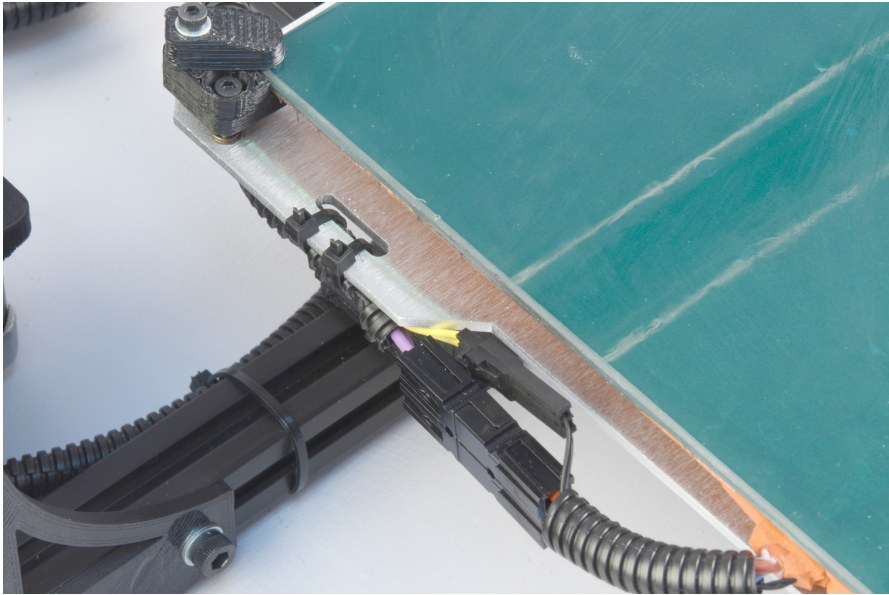

Figure 1.8: Tightly wrap the zip ties around the bed wires and through the strain relief slot

7. Now that the Y axis is mounted you should set your printer on a stable, flat, and level surface large enough for extra space around the printer. Make sure your printer work space is clear of anything that could obstruct the movement of the printer. **Make sure there are no flammable fabrics or liquids near the printer space.** It is also best to not put your printer near a drafty window or air conditioner vent.
8. Unwrap the power supply and USB cables.
MAKE SURE THE POWER SUPPLY IS COMPLETELY UNPLUGGED BEFORE MOVING ON TO THE NEXT STEP.
9. Locate the power supply and USB receptacles along the back of the TAZ electronics enclosure (Fig. 1.9, page 20). Locate the power supply and the included AC power cable (Fig. 1.10, page 21). Locate the DC power cable plug on the power supply. Connect the DC locking plug into the DC connector on the TAZ electronics enclosure (Fig. 1.11, page 21). The plug is keyed which may require rotating the plug until the keys line up and the plug can be pushed in. Once you have

pushed in the plug turn the locking sleeve clockwise until it is tight against the electronics enclosure (Fig. 1.12, page 22).

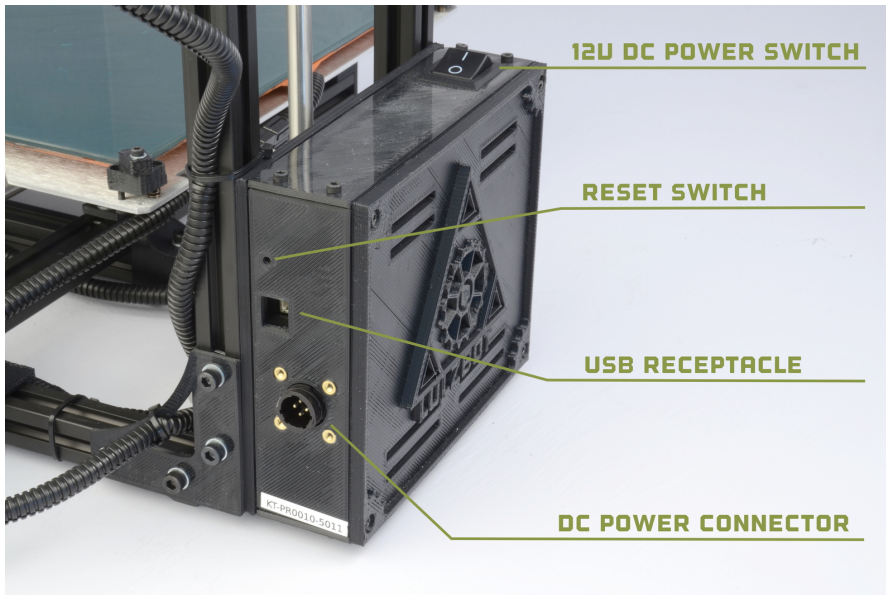

Figure 1.9: Power supply and USB receptacles



Figure 1.10: Power supply



Figure 1.11: 12V DC Power supply plug and receptacle



Figure 1.12: The power supply plug correctly plugged in

10. Locate, on the right of the power supply, the red AC voltage switch. Depending on your location you will need to change the AC voltage switch to 115V or 230V. North America is generally 115V and the majority of other regions are 230V. You can find general voltage by country at wikipedia.org/wiki/Mains_electricity_by_country.
11. Plug in the USB cable, B plug (square plug) side, into the USB receptacle on the printer electronics. Plug the other end of the USB cable, A plug side, into your computer.
12. Locate the filament guide with attached PTFE tube (Fig. 1.13, page 23). The filament guide attaches to the filament guide mount which can be found on the top right side of the printer frame. The filament guide easily pops on to the guide mount as shown in figure 1.14 (pg. 23).



Figure 1.13: Filament Guide

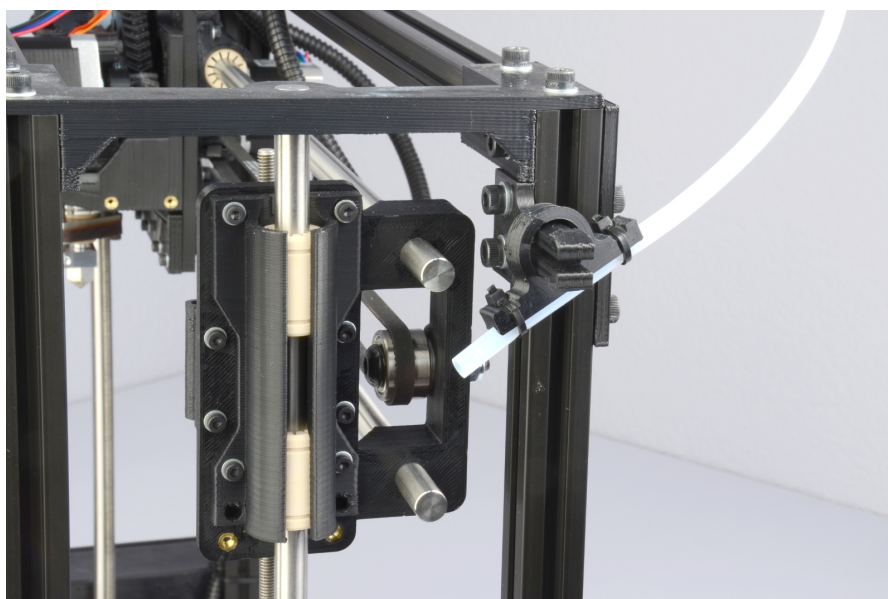

Figure 1.14: Filament Guide Setting

13. Your TAZ 3D printer is now setup and ready to start printing. Before moving forward you should become familiar with the TAZ Cartesian type system. The printer moves in three axes: X, Y, and Z (Fig. 1.15, page 24). These three axes allow the tool head to move to any point within the print area. Note the location of the mechanical end stops which are small switches located at the home point of each axis (Fig. 1.16, page 25). Each end stop switch allows the printer to find the 0, the origin, or starting point, of each axis. The mechanical end stops should never be blocked during the initial homing function or during a print.

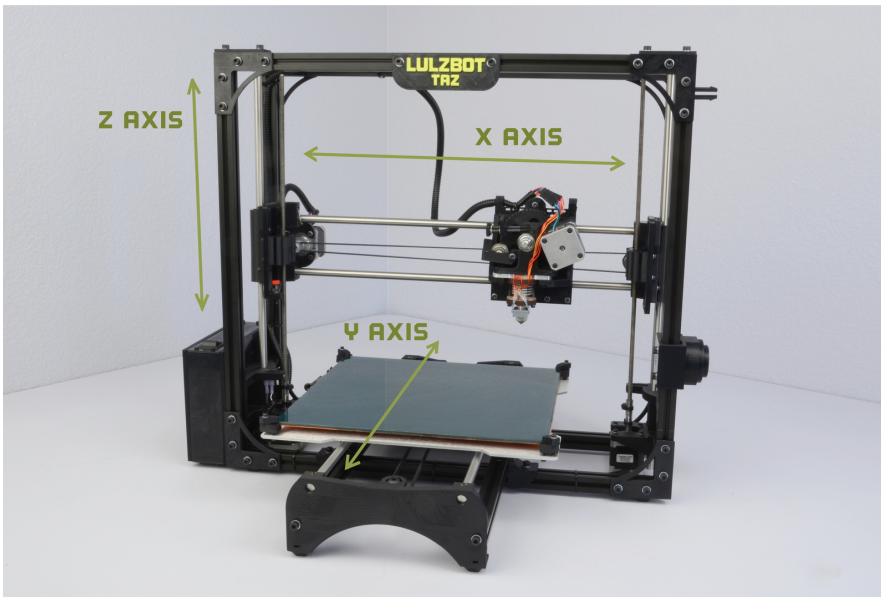

Figure 1.15: Axes movement directions

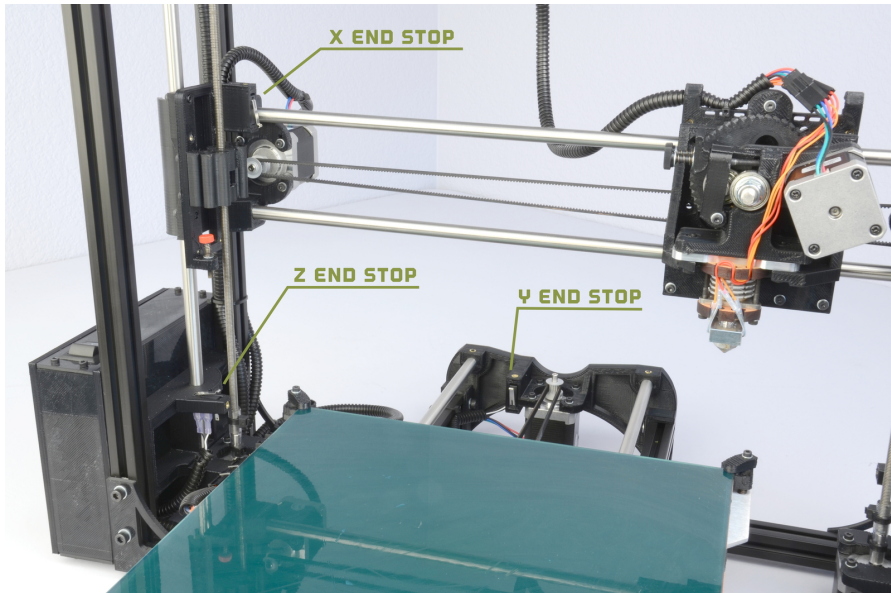

Figure 1.16: End stop locations

3D Printer Software

2.1 Software Overview

Aleph Objects, Inc., the maker of the LulzBot TAZ completely supports free/libre hardware and software. Along with the TAZ being a free/libre hardware design, it has been tested to work with 100% free/libre software. To operate your desktop 3D printer you will need to install a few software packages onto your PC. You will need a 3D printer host, an .STL to .gcode generator, and optional CAD or 3D modeling software.

All of the following free/libre software is available for GNU/Linux, Windows, and Apple OS X. However, we highly recommend using these softwares on GNU/Linux.

The required software can be found in the Support/Downloads section at <https://www.lulzbot.com/?q=support>. You will also find instructions there for installing each program onto your PC. You can also find downloads specific to the TAZ 3D printer on the TAZ product page.

2.2 Drivers

You will need to install device drivers in order for your Windows computer to communicate with the TAZ 3D Printer. A Windows guide can be found at: <https://www.lulzbot.com/support/manually-installing-drivers-windows>. If you are using your TAZ 3D Printer on a Linux/Apple OS X based computer you will not need any drivers- support is already built into the operating system.

Windows Driver Downloads: <http://download.lulzbot.com/TAZ/software/current/drivers/windows/>

2.3 Slic3r

Website: <http://www.slic3r.org>

The Slic3r software is the first tool in the chain of 3D printing software (Fig. 2.1, page 29).

Slic3r uses commonly used .STL files to create .gcode files. Gcode files contain instructions for the 3D printer on where, when, and how fast to make movements. However, Gcode programming is not very suitable for CAD and 3D design. This is where Slic3r and the .STL file comes into use. The .STL file is a 3D model file that can be exported by all common CAD

2.3. SLIC3R

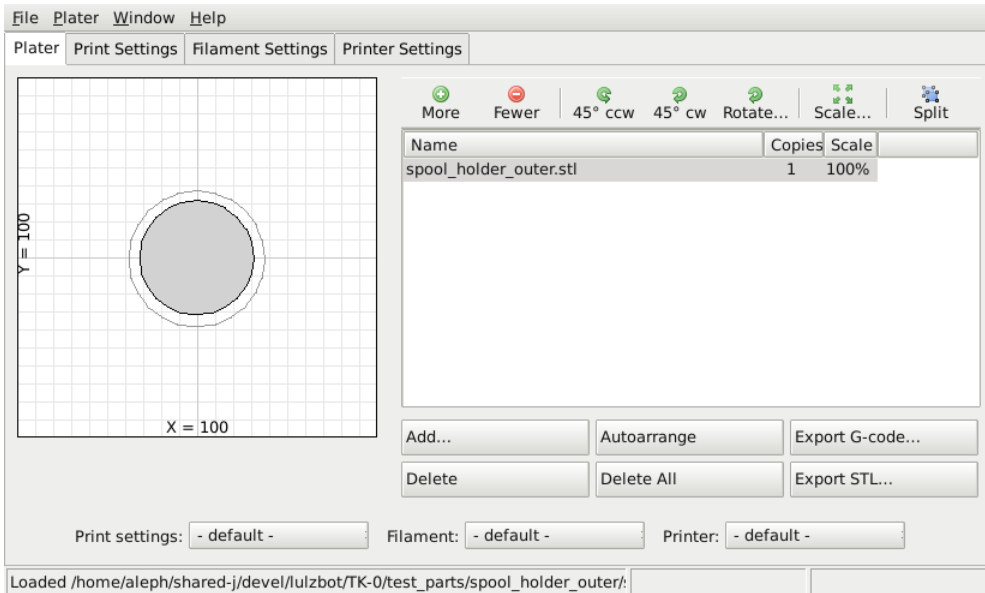

Figure 2.1: Slic3r application, STL to Gcode generator

and 3D modeling software. The Slic3r software then slices the `.STL` 3D model into layers and print paths to create a 3D printable `.gcode` file.

To launch Slic3r navigate to the `Slic3r` directory and launch the `slic3r.pl` file. On GNU/Linux operating systems you may need to set the `slic3r.pl` file as executable. On other operating systems it may be called `slic3r.exe`.

Slic3r includes very simple settings that allow you to easily refine prints. You can create multiple configurations for changing printer setups including nozzle sizes and desired print resolution. For ease of use we have pre-defined Slic3r profiles available in the Support/Downloads section and on the TAZ product page at www.LulzBot.com. Download the configurations to your `Slic3r` directory. We highly recommend starting with our pre-defined Slic3r profiles for your first couple prints.

Loading Configurations

To load configurations press the `Load Config...` button. In the file browser that opens, locate the downloaded configuration files. Select the configuration file that matches the nozzle size currently installed on

the printer (0.35mm nozzle is installed by default). Press **Open** and the pre-defined configuration will load into Slic3r. You can also save custom configurations for yourself by pressing the **Export Config...** button. A file browser will open that allows you to define a name and save your custom configuration.

Loading STL files

To load an **.STL** 3D model file into Slic3r, activate the **Plater** tab and click the **Add...** button. In the file browser navigate to the **.STL** you wish to load and click **Open**. The silhouette of the model will appear in the **Plater** diagram. To print more than one copy of the model at a time select the model name from the list and click the **More** button. With each press of the **More** button an additional copy of the model will be added to **Plater**. To remove a copy of the model select the model name again and click **Less**. To completely remove the model from **Plater** select the model name and click **Delete**.

Export Gcode files

Once you have finished setting your part(s) in **Plater** you can generate the **Gcode** by clicking **Export G-Code...** In the file browser navigate to where you would like to save the **.gcode** file and list a name to save the file as. Click **Save** and Slic3r will begin generating the **.gcode** file. When Slicer is finished you will receive a prompt. If you have created a plate with multiple model designs you can also use the **Export STL...** function to save an **.STL** file for quickly reproducing the same plate of models.

More on Slic3r

The above is a summarized explanation to quickly get you started slicing models and printing. For more in depth information on Slic3r including specific installation instructions see the chapter, **Slic3r in Depth**.

2.4 Printrun

Website: <http://www.github.com/kliment/Printrun>

2.4. PRINTRUN

The host software, Printrun, is used to start up and control your 3D printer (Fig. 2.2, page 31). The host controls include: setting the extruder

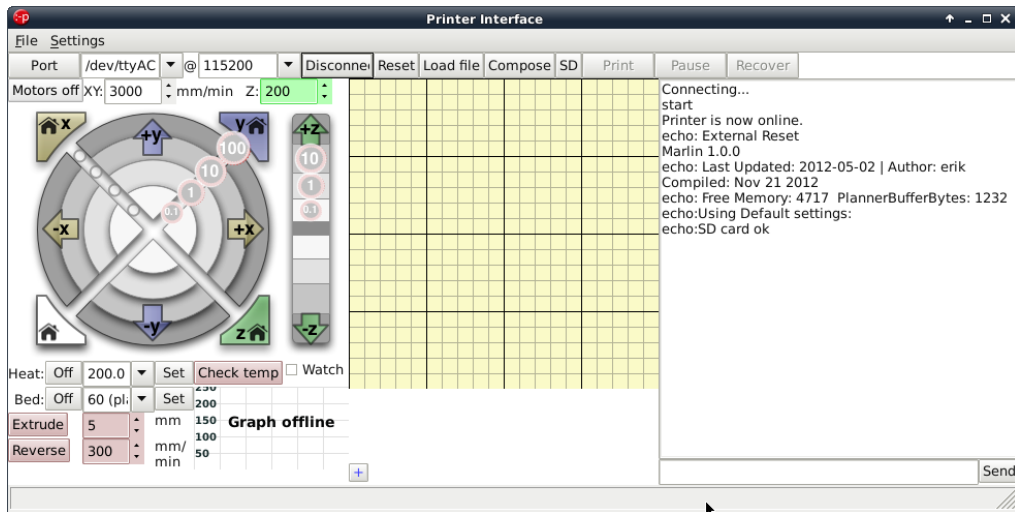

Figure 2.2: Printrun application for 3D printer control

and print surface temperatures, manual control of each axis, and manual extrusion. The host is also where you will push print files (`.gcode`) to the 3D printer for printing out model designs.

To launch Printrun, navigate to the `Printrun` directory and launch the `pronterface.py` file. On GNU/Linux operating systems you may need to set the `pronterface.py` file as executable. Depending on your environment you may need to launch the program by using the full command: `python pronterface.py`. On other operating systems the file may be called `pronterface.exe`.

Connecting the Printer

To start up the printer, first you will need to connect to the printer with Printrun. Make sure you have connected the USB cable from your PC to the printer before launching Printrun. If not, close Printrun, connect the USB cable, and relaunch Printrun. In the top left `Port` pull down menu select the correct port for the printer (generally `/dev/ttyACM0`). On other operating systems the port may be named such as `COM1` or `tty.usbserial-USB-ID`. If you only have one printer connected there will only be one port available

to select. Make sure the port baud rate is set to 115200 in the pull down menu to the right of the port selection. You can refresh the USB ports, by clicking the **Port** button.

Now, to connect to the printer click the **Connect** button. In the text output window you will see multiple return lines. If you see **Printer is now online** you have successfully connected to the printer. The printer control buttons on the left will also darken and become click-able after connecting. When you need to disconnect the printer simply press the **Disconnect** button.

Printer Controls

All of the printer controls can be found on the left side of the Printrun interface (Fig. 2.3, page 32). To set the hot end and print surface

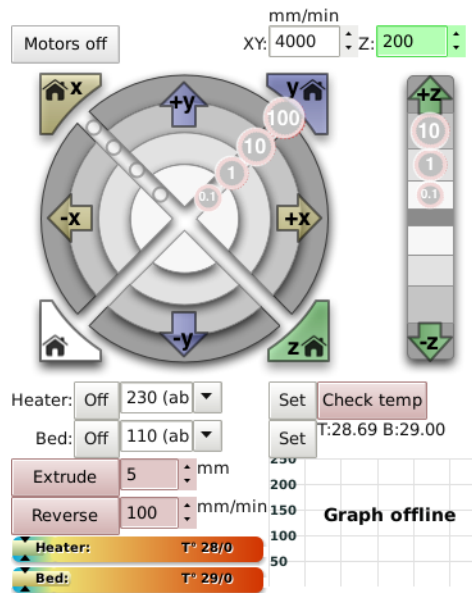

Figure 2.3: Printrun controls

temperature first click the **Monitor Printer** check box on. This will enable the printer temperature bars and graph. The hot end and print surface controls are labeled **Heater** and **Bed**. Select the temperature setting by using the pull down menu for pre-defined temperature settings. You can also set custom temperature settings by typing into the temperature box.

2.4. PRINTRUN

To turn on the hot end and/or printer surface click the respective **Set** button. The **Set** button will highlight orange when the temperature is set to on for that component. When the hot end or print surface is set to on you will see the temperature bar and graph display the set temperature and the current temperature. When both components have reached the correct temperature, the printer is ready for printing. Clicking the **Off** button will turn off that component and highlight the **Off** button blue.

Below the temperature controls are the manual extrusion controls. There you can manually extrude plastic through the hot end and retract the plastic filament from the hot end. The **Extrude** button will feed the amount of plastic, set to the right in mm, through the hot end. The rate at which the plastic is fed is set below the extrusion length (mm/min). The **Reverse** button will perform the opposite of **Extrude**, pulling the plastic filament back out of the hot end.

The large pattern of buttons above the temperature controls are the axes manual controls. These functions allows you to manually move each of the three axes of the printer. The circular pattern of four quadrants controls the X and Y axes. The top and bottom quadrants move the Y axis; the top in the positive direction (forward) and the bottom in the negative direction (back). The left and right quadrants move the X axis; the left in the negative direction (left) and the right in the positive direction (right).

Each quadrant is split into four sections that control the length of movement of 0.1mm, 1mm, 10mm, or 100mm. The innermost section moves the axis 0.1mm with each section outwards a larger movement with the outside section moving the axis 100mm.

The linear control bar to the right controls the Z axis. The Z axis is also separated into multiple movement lengths; 0.1mm, 1mm, and 10mm. The upper three buttons move the Z axis up and away from the printer surface; the three lower buttons move the Z axis closer to the print surface.

The four triangular buttons around the circular pattern are the axes home buttons. Each home button will move that axis in the negative direction until the end stop is activated. There is a home button for the X, Y, and Z axes. There is also a white home all button that homes all of the axes at once.

The **Motors off** button will deactivate all motors allowing all of the axes to be moved by hand.

Caution: when homing, the axis will continue to move in the negative direction until the end stop switch is activated. If the printer is ever

transported make sure the end stop switches are clear before resuming printing. If an axis has missed an end stop and is continuing to try to move in the negative direction, immediately turn the power switch to the off position. If a print file was running, after turning the power switch to off, pause the print by clicking the **Pause** button. Clear whatever is blocking the end stop and try homing again.

Loading Print Files

To load a `.gcode` file into Printrun click the **Load file** button. Navigate to the `.gcode` file in the file browser and click **Open**. You will now see a 2D images of the first layer of your model design in the Gcode viewer (Fig. 2.4, page 34). Click the Gcode viewer window to see a more detailed version

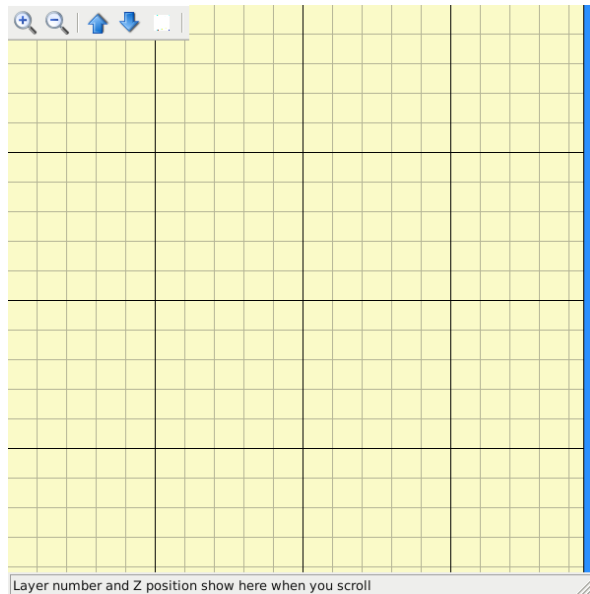

Figure 2.4: Printrun viewer

of the sliced model. In the pop-up Gcode viewer you can zoom in using the mouse scroll wheel and flip through layers with the up and down arrow keys. To pan within the window left-click and drag to move around the work plane. The lines shown in the Gcode viewer represent the path the extrusion nozzle will follow to print the model.

2.5. CAD AND 3D MODELING SOFTWARE

For more information on using Printron see the Printron page in the Support/Downloads section at <https://www.lulzbot.com/?q=support>. Instructions for running a print can be found in the Starting the First Print section in this manual.

2.5 CAD and 3D Modeling Software

Currently LulzBot is not distributing a CAD or 3D modeling software package. However, there are multiple free/libre software packages available. Other common non-free CAD and 3D modeling software are also capable of exporting the required .STL files.

On some CAD and 3D modeling software you will need to select millimeters as the output unit. If possible it is best to build your 3D design in metric units rather than imperial units. Slic3r requires .STL files sized in millimeters. If an .STL with inches as units is loaded into the Slic3r, the model will be scaled much smaller than expected. The software listed below outputs millimeters as the unit by default.

FreeCAD

Website: <http://free-cad.sourceforge.net>

FreeCAD is a great free/libre CAD application. Containing a full GUI for building CAD models, FreeCAD is capable of creating simple to complex designs. STL files can also easily be exported for use with 3D printing. FreeCAD is available for GNU/Linux, Windows, and Mac. The latest development version is recommended.

Blender

Website: <http://blender.org>

The most widely used Free/Libre 3D modeling software, Blender is well documented with tutorials available on the Blender.org website. Numerous video tutorials can be also found online.

Shapesmith

Website: <http://shapesmith.net>

Shapemith is a web based 3D modeling software. This means there is no required software to get started designing models. Shapemith is also a great choice for anyone just starting out in CAD/ 3D modeling.

OpenSCAD

Website: <http://openscad.org>

OpenSCAD is another free/libre CAD software; however, different than FreeCAD, it is script based. Rather than using a GUI to generate CAD designs, OpenSCAD CAD designs are created using script based renderings. Users with programming experience would find this very useful. Also, OpenSCAD uses a simple script language that is easy to learn for users with little or no programming experience.

Slic3r in Depth

3.1 Intro

Overview

Slic3r is a tool which translates digital 3D models into instructions that are understood by a 3D printer. It slices the model into horizontal layers and generates suitable paths to fill them.

Slic3r is already bundled with the many of the most well-known host software packages: Pronterface, Repetier-Host, ReplicatorG, and can be used as a standalone program.

This manual will provide guidance on how to install, configure and utilise Slic3r in order to produce excellent prints.

Goals & Philosophy

Slic3r is an original project started in 2011 by Alessandro Ranellucci (aka. Sound), who used his considerable knowledge of the Perl language to create a fast and easy to use application. Readability and maintainability of the code are among the design goals.

The program is under constant refinement, from Alessandro and the other contributors to the project, with new features and bug fixes being released on a regular basis.

Donating

Slic3r started as a one-man job, developed solely by Alessandro in his spare time, and as a freelance developer this has a direct cost for him. By generously releasing Slic3r to the public as open source software, under the GPL license, he has enabled many to benefit from his work.

The opportunity to say thank you via a donation exists. More details can be found at: <http://slic3r.org/donations>.

3.2 Getting Slic3r

Slic3r is Free Software, and is licensed under the GNU Affero General Public License, version 3.

Downloading

Slic3r can be downloaded directly from: <http://slic3r.org/download>.

Pre-compiled packages are available for GNU/Linux, Mac OS X and Windows. GNU/Linux and Windows users can choose between 32 and 64 bit versions to match their system.

Source

The source code is available via github: <https://github.com/alexrj/Slic3r>
(For more details see §3.6)

Manual

The latest version of this document, with L^AT_EX source code is presently at:
<http://devel.lulzbot.com/Slic3r/>

Installing

GNU/Linux

Extract the archive to a folder of your choosing. Either:

- Start Slic3r directly by running the Slic3r executable, found in the bin directory, or
- Install Slic3r by running the do-install executable, also found in the bin folder.

The archive file may then be deleted.

Windows

Unzip the downloaded zip file to a folder of your choosing, there is no installer script. The resulting folder contains two executables:

- `slic3r.exe` - starts the GUI version.
- `slic3r-console.exe` - can be used from the command line.

The zip file may then be deleted.

Mac OS X

Double-click the downloaded dmg file, an instance of Finder should open together with an icon of the Slic3r program. Navigate to the Applications directory and drag and drop the Slic3r icon into it. The dmg file may then be deleted.

3.3 First Slice

LulzBot provides ready-made Slic3r profiles for immediate use to get printing quickly. You can find the TAZ Slic3r profiles at <http://download.lulzbot.com/TAZ/software/current/slic3r/config/>. Once you have become familiar with your TAZ printer and the software you may want to make your own profiles with slight adjustments for particular designs.

Configuration Wizard

Slic3r has two features to aid newcomers: the configuration wizard, and simple mode.

Sometimes it is nice to have a helping hand when starting out with new software. The configuration wizard asks a series of questions and creates a configuration for Slic3r to start with.

3.3. FIRST SLICE



Figure 3.1: Configuration Wizard: Welcome Screen

1. Firmware Type

The gcode produced by Slic3r is tailored to particular types of firmware. The first step prompts for the firmware that the printer uses. This should have been specified when the printer was built or configured. The TAZ printer uses the RepRap (Marlin/Sprinter) gcode type.



Figure 3.2: Configuration Wizard: Firmware Type

3.3. FIRST SLICE

2. Bed Size

This setting defines the maximum distance the extruder may travel along the X and Y axis. If the dimensions are not readily available for the printer then it can be easily measured.

Be sure to measure from the lower left corner where the extruder nozzle rests when in the home position to the maximum distance the nozzle can travel in each direction. Take into account that the X carriage may touch the frame before the nozzle reaches it's full distance, this will depend on the printer make and model.

Also remember to check any firmware end-stop settings which may limit X/Y movement.

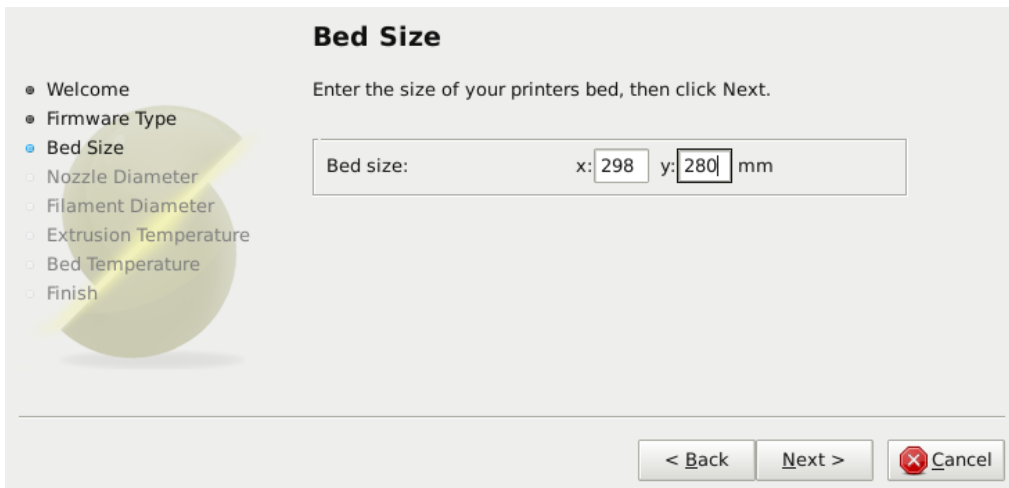

Bed Size

Enter the size of your printers bed, then click Next.

Bed size: x: 298 y: 280 mm

< Back Next > 

Figure 3.3: Configuration Wizard: Bed Size

3. Nozzle Diameter

The diameter of the hot-end nozzle is usually clearly displayed either in the description of the hot-end, or in the associated documentation, when the hot-end is purchased. Common values are 0.5mm and 0.35mm.

If the nozzle was home-made, or came from a source without a diameter given, then carefully measure the aperture as accurately as possible. One way of determining nozzle size is to very slowly (1mm/s) extrude some filament into free air and measure the thickness of the resulting extrusion¹. This has the benefit of taking die swell into account, and consequently may be a useful thing to do even if the diameter is known.

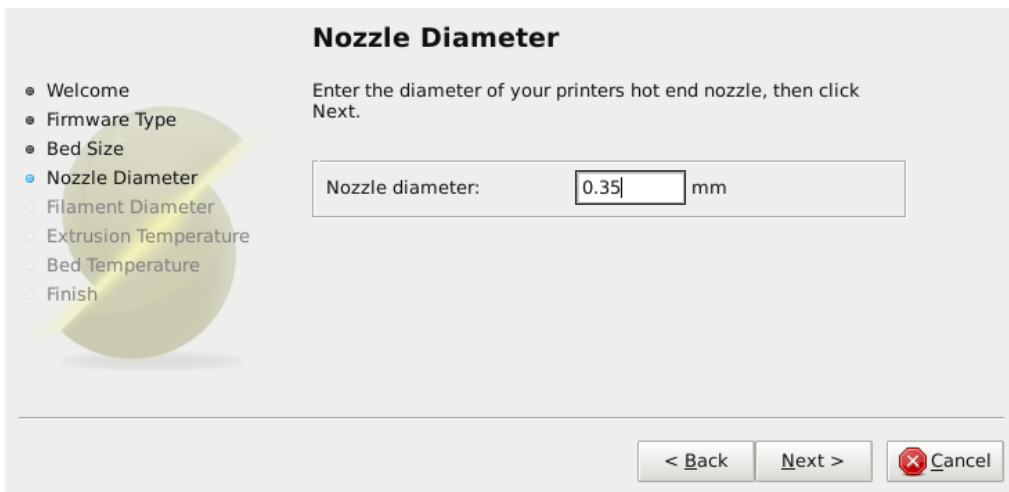

Figure 3.4: Configuration Wizard: Nozzle Diameter

¹<http://forums.reprap.org/read.php?1,113374,113953>

3.3. FIRST SLICE

4. Filament Diameter

For Slic3r to produce accurate results it must know as accurately as possible how much material is pushed through the extruder. Therefore it is vital to give it as precise a value as possible for the filament diameter.

Although the filament used in FDM printers is sold as being either 3mm or 1.75mm this is only a general guide. The diameter can vary between manufacturers and even between batches. Therefore it is highly recommended to take multiple measurements from along a length of the filament and use the average. For example, measurements of 2.89, 2.88, 2.90 and 2.91 would yield an average of 2.895, and so this would be used.

Filament Diameter

- Welcome
- Firmware Type
- Bed Size
- Nozzle Diameter
- **Filament Diameter**
- Extrusion Temperature
- Bed Temperature
- Finish

Enter the diameter of your filament, then click Next.

Good precision is required, so use a caliper and do multiple measurements along the filament, then compute the average.

Diameter: mm

< Back Next > Cancel

Figure 3.5: Configuration Wizard: Filament Diameter

5. Extrusion Temperature

The extrusion temperature will depend on the material, and most can operate over a range of temperatures. The supplier should provide guidance as to which temperatures are suitable. A very general rule of thumb is that PLA lies between 160°C and 230°C, and ABS lies between 215°C and 250°C. More exotic materials will have a different range.

This is one parameter which you will want to fine tune when you start producing prints. The optimal temperature can vary even between colours of the same material. Another factor which may affect the chosen temperature is how fast the extrusion is, where generally faster extrusion runs hotter.

Note: One may choose to control the extruder temperature manually from the printer controller. In this case the temperature can be set to zero.

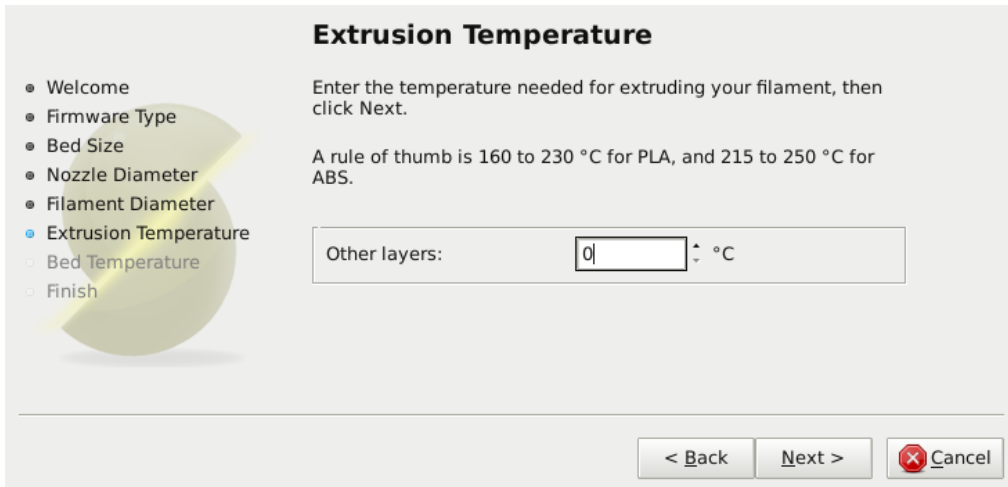

The screenshot shows the 'Extrusion Temperature' step of the Slic3r Configuration Wizard. On the left, a vertical list of steps is shown: Welcome, Firmware Type, Bed Size, Nozzle Diameter, Filament Diameter, Extrusion Temperature (highlighted with a blue dot), Bed Temperature, and Finish. The main area contains the title 'Extrusion Temperature', instructions to enter the temperature and click Next, and a rule of thumb for PLA (160 to 230 °C) and ABS (215 to 250 °C). A text input field labeled 'Other layers:' contains the value '0' followed by a degree symbol and 'C'. At the bottom right, there are three buttons: '< Back', 'Next >', and a red 'X' 'Cancel' button.

Figure 3.6: Configuration Wizard: Extrusion Temperature

6. Bed Temperature

If the printer has a heated bed then this parameter may be set. As with the extruder temperature, the value will depend on the material used. A rule of thumb is that PLA requires 60°C and ABS requires 85°C.

Note: One may choose to control the bed temperature manually from the printer controller. In this case the temperature can be set to zero.

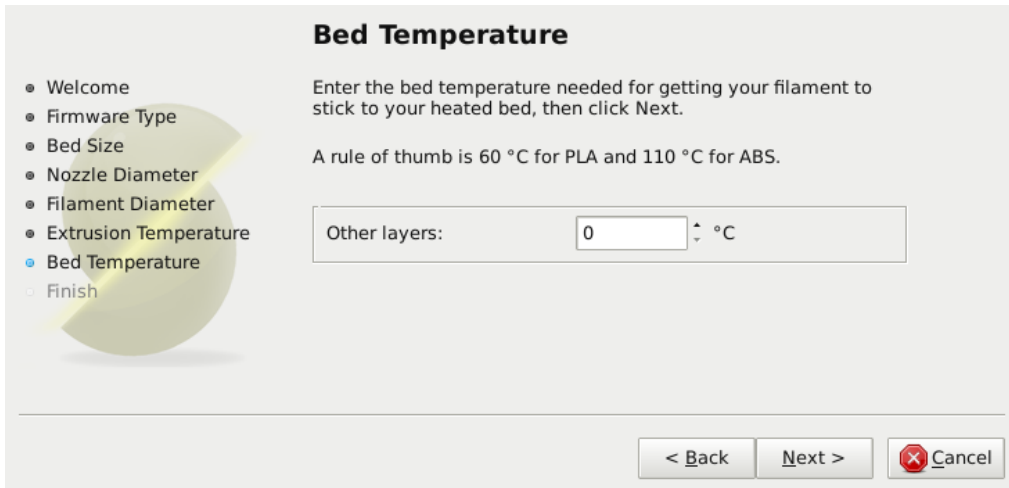

Bed Temperature

Enter the bed temperature needed for getting your filament to stick to your heated bed, then click Next.

A rule of thumb is 60 °C for PLA and 110 °C for ABS.

Other layers: °C

< Back Next >  Cancel

Figure 3.7: Configuration Wizard: Bed Temperature

At this stage the wizard is complete and the basic configuration is defined.

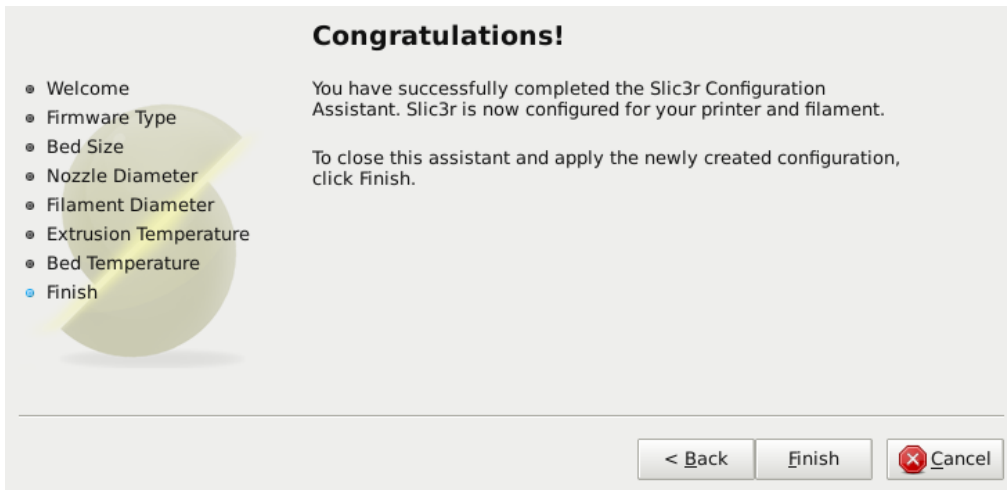

Figure 3.8: Configuration Wizard: End

The Important First Layer

Before delving into producing the first print it is worthwhile taking a little detour to talk about the importance of getting the first layer right. As many have found through trial and error, if the first layer is not the best it can be then it can lead to complete failure, parts detaching, and warping. There are several techniques and recommendations one can heed in order to minimise the chance of this happening.

Level bed. Having a level bed is critical. If the distance between the nozzle tip and the bed deviates by even a small amount it can result in either the material not lying down on the bed (because the nozzle is too close and scrapes the bed instead), or the material lying too high from the bed and not adhering correctly.

Higher temperature. The extruder hot-end and bed, if it is heated, can be made hotter for the first layer, thus increasing the viscosity of the material being printed. As a rule of thumb, an additional 5° is recommended.

3.3. FIRST SLICE

Lower speeds. Slowing down the extruder for the first layer reduces the forces applied to the molten material as it emerges, reducing the chances of it being stretched too much and not adhering correctly. 30% or 50% of the normal speed is recommended.

Correctly calibrated extrusion rates. If too much material is laid down then the nozzle may drag through it on the second pass, causing it to lift off the bed (particularly if the material has cooled). Too little material may result in the first layer coming loose later in the print, leading either to detached objects or warping. For these reasons it is important to have a well-calibrated extrusion rate.

First layer height. A thicker layer height will provide more flow, and consequently more heat, making the extrusion adhere to the bed more. It also gives the benefit of giving more tolerance for the levelness of the bed. It is recommended to raise the first layer height to match the diameter of the nozzle, e.g. a first layer height of 0.35mm for a 0.35mm nozzle. Note: The first layer height is set this way automatically in simple mode.

Wider extrusion width. The more material touching the bed, the better the object will adhere to it, and this can be achieved by increasing the extrusion width of the first layer, either by a percentage or a fixed amount. Any spaces between the extrusions are adjusted accordingly.

A value of approximately 200% is usually recommended, but note that the value is calculated from the layer height and so the value should only be set if the layer height is the highest possible. For example, if the layer height is 0.1mm, and the extrusion width is set to 200%, then the actual extruded width will only be 0.2mm, which is smaller than the nozzle. This would cause poor flow and lead to a failed print. It is therefore highly recommended to combine the high first layer height technique recommended above with this one. Setting the first layer height to 0.35mm and the first extrusion width to 200% would result in a nice fat extrusion 0.35mm wide.

Bed material. Many options exist for the material to use for the bed, and preparing the right surface can vastly improve first layer adhesion.

PLA is more forgiving and works well on PET, Kapton, or blue painters tape.

ABS usually needs more cajoling and, whilst it can print well on PET and Kapton, there are reports that people have success by applying hairspray to the bed before printing. Others have reported that an ABS slurry (made from dissolving some ABS in Acetone) thinly applied can also help keep the print attached.

No cooling. Directly related with the above, it makes no sense to increase the temperature of the first layer and still have a fan or other cooling mechanism at work. Keeping the fan turned off for the first few layers is generally recommended. Of course, some models may need direct cooling due to their size, but this would be an exception.

Simple Mode

Slic3r has two modes of operation, Simple and Expert. These may be chosen from the **Preferences** window (found under the **File** menu).

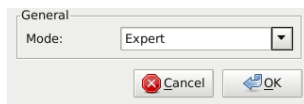

As is expected, the simple mode offers a reduced set of options, enough for the beginner to get started with. The expert options give more control over how Slic3r produces the gcode and will be looked at later.

Print Settings

The **Print Settings** tab provides the opportunity to change settings related to the actual print. Whereas the other tabs are changed rarely, the settings on this tab will be modified regularly, possibly for each model printed.

General. **Layer height** is the thickness of each layer, and it is the step along the vertical axis taken before extruding a new layer atop the previous one. There are several factors that influence how high each layer should be:

- **Desired resolution** - Lower layer height should result in prints with less noticeable ribs or bands, as each layer is smaller. Aesthetics plays a role here, but also the type of model, for example, a mechanical part

3.3. FIRST SLICE

The screenshot shows the Slic3r software interface with the 'Print Settings' dialog box open. The dialog is organized into several sections:

- General:** Layer height: 0.3 mm; Perimeters (minimum): 2; Solid layers: Top: 3, Bottom: 3.
- Infill:** Fill density: 0.3; Fill pattern: rectilinear.
- Support material:** Generate support material: ; Pattern spacing: 2.5 mm; Raft layers: 0 layers.
- Speed:** Perimeters: 30 mm/s; Infill: 60 mm/s; Travel: 130 mm/s.
- Brim:** Brim width: 0 mm.
- Sequential printing:** Complete individual objects: ; Extruder clearance (mm): Radius: 20, Height: 20.

At the bottom of the dialog, there is a link: 'Want more options? Switch to the Expert Mode.' The status bar at the very bottom of the window reads: 'Version 0.9.9 - Remember to check for updates at <http://slic3r.org/>'.

Figure 3.9: Simple Mode: Print Settings.

may not need such a high resolution finish, whereas a presentation piece may do so.

- **Print speed** - Shorter layers will result in smoother prints but each print will take longer, simply because the extruder must trace the pattern more times. A later goal will be to strike a balance between layer height, the speed of the printer, and the quality of the resulting print.

Perimeters defines the minimum number of vertical shells (i.e. walls) a print will have. Unless the model requires single width walls it is generally

recommended to have a minimum of two perimeters as this gives some insurance that if a section of the perimeter is not printed correctly then the second perimeter will help cover it.

The upper and lowermost layers that sandwich the model are filled with a **Solid layers** pattern. For the bottom layers the important factor to consider is how the surface will look should there be a mistake whilst laying down the first layer, and for this reason it is recommended to have at least two bottom layers.

A similar consideration is required for the top layers. Because the intermediate layers are likely to be filled with a pattern set less than 100% then the covering layers will have to bridge this pattern and this can require more than one pass to cover completely.

Another tip to consider: Setting the top solid layer to zero, and setting the infill also to zero, will result in a hollow receptacle, ideal for turning models into vases² for example. Here manipulating the settings within Slic3r can be used to generate different kinds of prints, and not only be used to control surface accuracy.

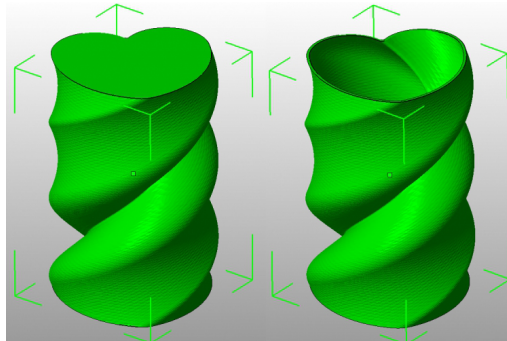

Figure 3.10: Creating a vase from a solid model.

Infill. Fill density is defined on a scale of between 0 and 1, where 1 is 100% and 0.4 would be 40%. For the majority of cases it makes no sense to 100% fill the model with plastic, this would be a waste of material and take a long time. Instead, most models can be filled with less material which is then sandwiched between layers filled at 100% (see **Solid layers** above).

²<http://slic3r.org/blog/tip-printing-vases>

3.3. FIRST SLICE

A density value of 0.4 is enough to give almost all models good mechanical strength. A value of 0.2 is usually the minimum required to support flat ceilings.

Slic3r offers several fill patterns which will be discussed in more depth in section 3.4 - Infill Choices. Choosing a pattern will depend on the kind of model, the desired structural strength, print speed, and personal taste. The more exotic fill methods are usually too slow and unnecessarily complex for most use cases, and so most of the time the infill pattern is either **rectilinear**, **line**, or **honeycomb**. Honeycomb gives the most strength but is slower than both rectilinear or line.

Support material. Printing a model from the bottom up, as with FDM, means that any significant overhangs will be printed in the air, and most likely droop or not print correctly. Choosing support material will add additional structures around the model which will build up to then support the overhanging part. The **Pattern spacing** option determines how dense the support material is printed.

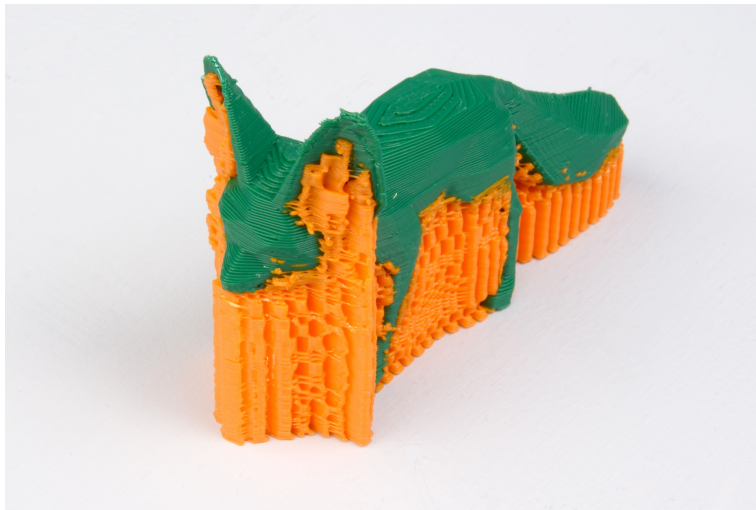

Figure 3.11: An example of support material.

Tip: It is sometimes worth considering altering the orientation of the model in order to possibly reduce overhangs.

Raft layers will add additional layers underneath the model and stems from the early days of 3D printing. It can help with prints without a heated

bed, or where the bed is not very flat, but it is usually not required and is not recommended. The raft also requires post-processing to remove it.

Speed. In simple mode there are only three speed settings to consider:

- **Perimeters** - The outline of the model may benefit from being printed slightly slower so that the outside skin of the print has fewer blemishes.
- **Infill** - As the infill is hidden this can be extruded a little faster. Take care though not to go too fast as higher speeds results in thinner extrusions, and this may affect how the extrusions bond.
- **Travel** - The jump between the end of one extrusion and the next should usually be performed as quickly as the printer will allow in order to minimise any mess caused by material oozing from the nozzle.

Brim. Brim is used to add more perimeters to the first layer, as a base flange, in order to provide more surface area for the print to stick to the bed with in order to reduce warping (see §3.3). The brim is then cut away once the print is finished and removed from the bed.



Figure 3.12: An example of brim.

Sequential printing. When printing several objects at once it can be useful to print each one separately as this will minimise oozing and strings running between the prints. Care has to be taken that the nozzle and extruder does not interfere with already printed parts. This is the reason for the `Extruder clearance` parameters:

3.3. FIRST SLICE

- **Radius** - The clearance that should be given around the extruder. Take care if the extruder is not mounted centrally - take the largest safe value.
- **Height** - The vertical distance between the nozzle tip and the X axis rods, or lowest part which may interfere with a finished print.

Filament Settings

The **Filament Settings** will normally be used infrequently, for example on receipt of a new roll of filament.

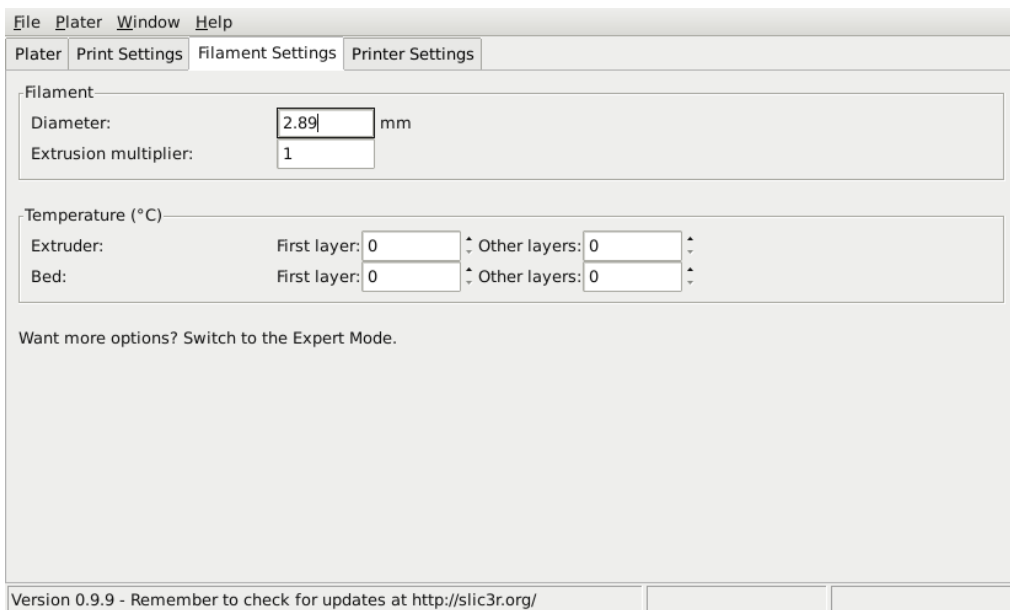

Figure 3.13: Simple Mode: Filament Settings.

Filament. The **Diameter** setting will already have been filled from the value given during the wizard (see p.45), but can be updated here.

The **Extrusion multiplier** setting allows the fine tuning of the extrusion flow rate, and is given as a factor, e.g. 1 means 100%, 1.5 would mean 150%. Whilst the value should ideally be set in the firmware it can be useful to test slight changes to the rate by altering this value. It varies

the amount of plastic proportionally and should be changed in very small steps (e.g. +/- 0.05) as the effects are very visible.

Temperature. These values are also filled from the wizard, but here the opportunity exists to set the temperature for the first layer (see p.48).

Printer Settings

The **Printer Settings** will be updated the least, unless Slic3r is going to be used for many printers, for example, in a 3D printer farm.

3.3. FIRST SLICE

The screenshot shows the Slic3r software interface with the 'Printer Settings' tab selected. The interface is organized into several sections:

- Size and coordinates:** Bed size: x: 298 mm, y: 280 mm; Print center: x: 149 mm, y: 140 mm; Z offset: 0 mm.
- Firmware:** G-code flavor: RepRap (Marlin/Sprinter).
- Extruder:** Nozzle diameter: 0.35 mm.
- Retraction:** Length: 1.6 mm (zero to disable); Lift Z: 0 mm.
- Start G-code:** G28 ; home all axes
- End G-code:** M400 ;
M104 S0 ; turn off nozzle temperature
M140 S0 ; turn off bed temperature
G1 Y280
G28 X0 ; home X axis
M84 ; disable motors

At the bottom, there is a status bar with the text: 'Version 0.9.9 - Remember to check for updates at <http://slic3r.org/>'.

Figure 3.14: Simple Mode: Printer Settings.

Size and coordinates. The **Bed size** setting is taken from the wizard (see p.43) and is only used for previewing the model in the plater.

The **Print center** is the point around which the print will be centered. A **Bed size** of 200mmx200mm and a **Print center** of 100mmx100mm would sit the print in the middle. Should it be desired to print away from the center, because of a scratch in the glass perhaps, then this option should be used.

Z offset can be used to compensate for an incorrectly calibrated Z end-stop. If the nozzle stops slightly too far from the bed, then adding a negative value will offset all layers by that amount. The correct solution however is to fix the end-stop itself.

The optimal Z endstop position is where the nozzle tip barely touches the surface of the bed when homed. A sheet of paper makes a good gauge for this very small distance. It is not recommended to use this setting to try and improve layer adhesion, by "squashing" the bottom layer into the bed, instead look at the suggestions in section 3.3.

Firmware. As selected in the wizard (see p.42), **G-code flavour** defines the dialect of G-code generated.

Extruder. **Nozzle diameter** was defined in the wizard (see p.44).

Retraction. Unless the material being extruded has a very high viscosity it may ooze between extrusions due to gravity. This can be remedied by actively retracting the filament between extrusions. Setting the **Length** parameter to a positive value will cause the filament to be reversed by that many millimeters before travel. The retraction will then be compensated for by the same amount after the travel move, before starting the new extrusion path.

A value of between 1 and 2mm is usually recommended. Bowden extruders may need up to 4 or 5mm due to the hysteresis introduced by the tube.

Setting the **Lift Z** parameter to a positive value will raise the entire extruder on the Z axis by that many millimeters during each travel. This can be useful to ensure the nozzle will not catch on any already laid filament, however it is usually not necessary and will slow the print speed. A value of 0.1mm is usually sufficient.

Start, End and Layer Change G-codes. Custom G-code commands can be run before a print starts, after a print finishes, and between each layer change.

3.3. FIRST SLICE

Placeholders can be inserted in the G-code commands³. For example [next_extruder] would return the index of the next extruder.

The RepRap wiki is a good resource to learn about the variety of G-codes available: <http://reprap.org/wiki/G-code>.

Note: Be sure to check that a given G-code is valid for your firmware. Some common G-codes to use before the print starts are:

- **G28** - Homes all the axes.

Some common G-codes to use after the print ends are:

- **M104 S0** - Sets the extruder temperature to zero.
- **M140 S0** - Sets the heated bed temperature to zero.
- **G28 X0** - Home the X axis.
- **M84** - Disables the motors.

Working with Models

Yet another step lies between now and the first print - a model has to be found and then sliced.

Model Formats

Slic3r accepts the following file types.

- STereoLithography (STL) files can come from a wide variety of sources and are now a de facto standard in 3D printing. The files simply describe the surface geometry of a 3D object without any additional information (such as colour or material), and it is this simplicity that has probably made the format ubiquitous.
- Wavefront OBJ files are an open format originally used in an animation application from Wavefront Technologies, but has since been adopted by the wider 3D modelling community. It is similar to the STL format.

³<https://github.com/alexrj/Slic3r/wiki/FAQ#what-placeholders-can-i-use-in-custom-g-code>

- Additive Manufacturing File Format (AMF) was developed in response to the limited nature of the STL format. In addition to describing the geometry of the 3D model it can also describe colours and materials, as well as more complex attributes, such as gradient mixes and multiple object arrangements (constellations). Whilst the format is deemed a standard it has yet to be widely adopted in the 3D maker community.

Finding Models

The 3D model files may come from an online repository, such as Thingiverse⁴ or GrabCAD⁵ or be created from a CAD program, such as FreeCAD⁶, OpenSCAD⁷, or an online CAD tool such as Shapsmith⁸.

You may wish to view the files before slicing and there are many free applications available: Meshlab⁹ or FreeCAD which can both be used to import, view, and repair STL models.

⁴<http://www.thingiverse.com>

⁵<http://grabcad.com>

⁶<http://sourceforge.net/projects/free-cad>

⁷<http://www.openscad.org>

⁸<http://shapsmith.net>

⁹<http://www.meshlab.org>

3.3. FIRST SLICE

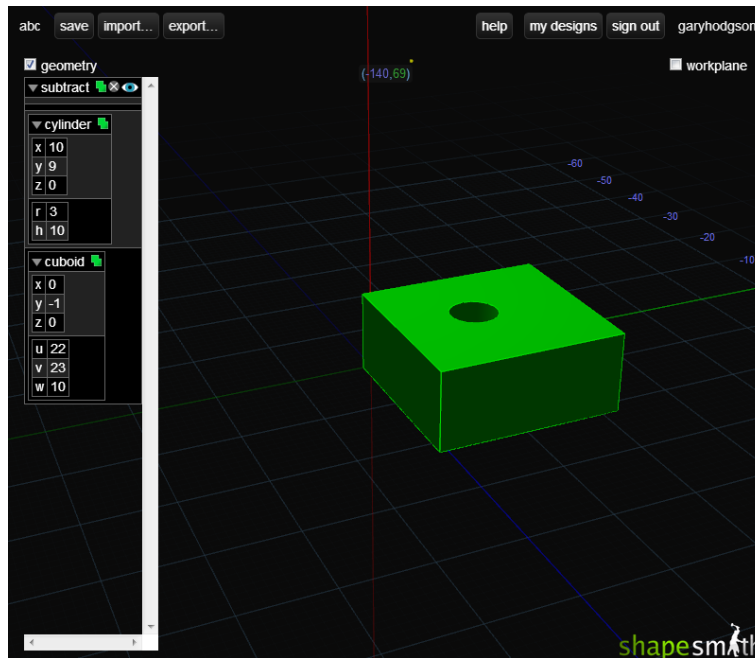

Figure 3.15: Shapeways online CAD tool.

Working with Plater

Slic3r has a tool, called Plater, which allows one or more models to be loaded and arranged before being sliced.

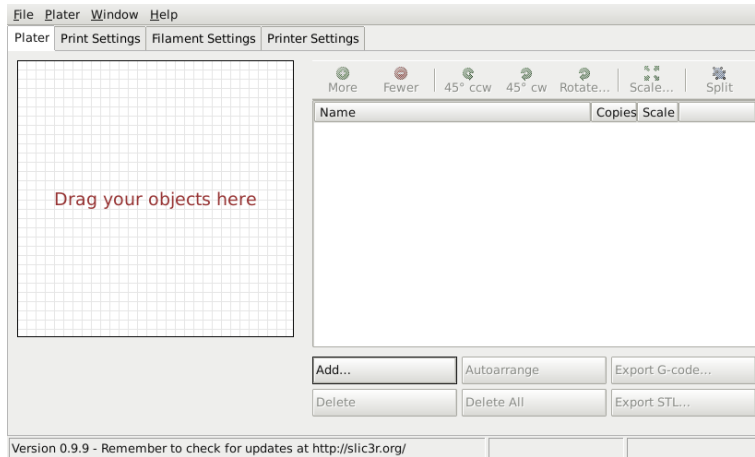

Figure 3.16: Plater

Once you have acquired a model, drag it onto the Plater window (or use the Add button below the file list) to load it into Slic3r. In the figure below, the traditional RepRap Minimug¹⁰ is loaded, and is viewed from above. The ring around the model is a skirt - a single perimeter, several millimeters away from the model, which is extruded first. This is useful in making sure the plastic is flowing smoothly from the nozzle when the model is starting to be printed.

¹⁰<http://www.thingiverse.com/thing:18357>

3.3. FIRST SLICE

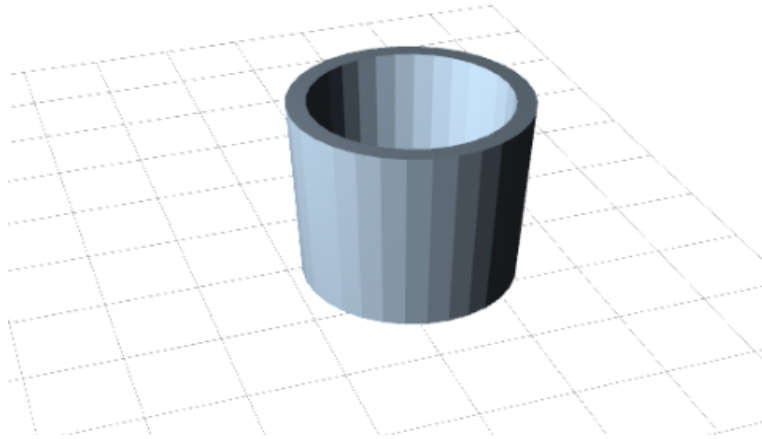

Figure 3.17: Minimug model.

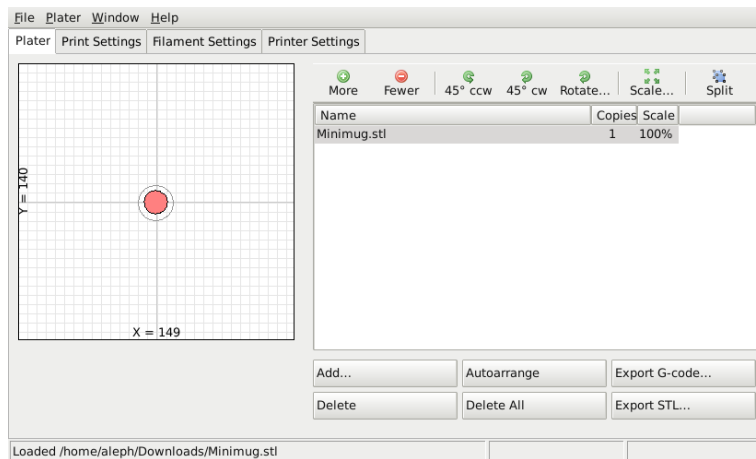

Figure 3.18: STL file loaded.

The model can be repositioned by dragging the representation of it on the left of the screen around the bed. Note that the dimensions of the bed should match your printer, as given during the initial configuration above.

On the right-hand side is the list of currently loaded files. The buttons along the top of the file list allow you to arrange the models.

- **More/Less** - Adjust how many copies should be printed.

- **45°/Rotate** - Rotate the selected model around the Z axis, either in 45° increments clockwise or counter-clockwise, or by a given amount.
- **Scale** - Increase or decrease the size of the printed model.
- **Split** - Divides a model which consists of more than one part into it's constituent parts, allowing each one to be arranged individually.

The buttons along the bottom of the file list allow you to add, remove, auto-arrange, or export the models.

- **Add** - Opens a file dialog to add a model to the plater, as an alternative to dropping a file directly.
- **Delete/Delete All** - Remove one or all models from the plater.
- **Autoarrange** - Attempt to arrange the models to give the optimal layout.
- **Export G-code** - Starts slicing the model and produces a G-Code file.
- **Export STL** - Save the current set of models as a single STL file.

Cleaning STLs

If the 3D mesh described in the model contains holes, or edges are misaligned (known as being non-manifold), then Slic3r may have problems working on it. Slic3r will attempt to fix any problems it can, but some problems are out of it's reach. If the application complains that a model cannot be sliced correctly then there are several options available, and the ones described here are all free at the time of writing.

FreeCAD Freecad is a comprehensive, and free, CAD program which comes with a mesh module, in which repairs to degenerate models can be made. the following steps outline how a problem model file can be analysed and repaired.

3.3. FIRST SLICE

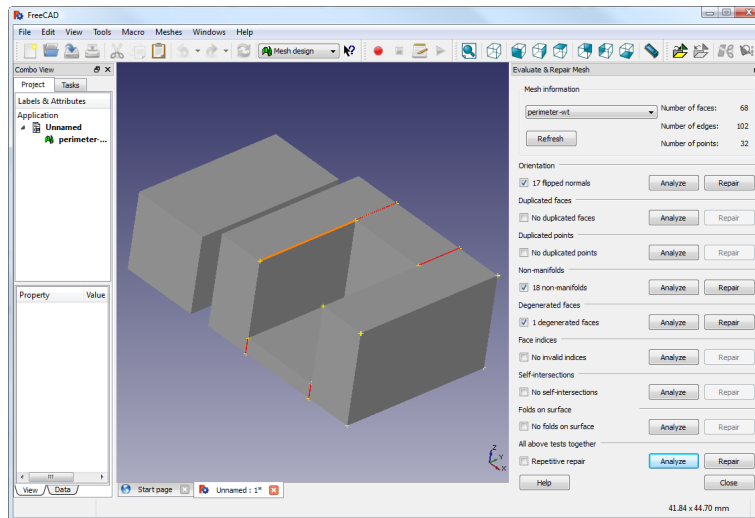

Figure 3.19: FreeCAD part repair.

- Start FreeCAD and from the start splash page choose **Working with Meshes**.
- Load the model by dragging and dropping it onto the workspace or via the **File** menu. A small message in the bottom left corner will indicate if the model appears to have problems.
- From the menu choose **Meshes->Analyze->Evaluate & Repair mesh** to bring up the repair options dialog.
- From the options dialog choose the loaded mesh, then perform each analysis by clicking the **Analyze** button by each problem type, or select **Repetitive Repair** at the bottom to perform all checks. If a corresponding problem is detected the **Repair** button becomes enabled.
- For each desired repair hit the **Repair** button.
- It is important to review the effect the repair script has made to the model. It may be the case that the script damages the file, rather than repair, for example by removing important triangles.
- Export the repaired model via the **Export** menu option or context menu.

First Print

At this stage Slic3r has been configured and a model has been acquired, sliced and made ready for print. Now would be the time to fire up the printer and try it out.

A variety of host software is available to send the G-code to the printer. Amongst the open-source solutions are: Printron¹¹, Repetier¹² and Reprap¹³.

The following sections will cover the options available in expert mode, and look at advanced printing techniques, including special cases and troubleshooting.

3.4 Expert Mode

Speed

Once the printer is reliably producing good quality prints it may be desirable to increase the speed. Doing this provides several benefits, the most obvious of which is that the results are produced quicker, but also faster print times can be utilised in producing more layers, i.e. lower layer height, thus improving perceived print quality. An additional benefit is that a faster travel movement, between extrusions, can reduce the effects of oozing.

The best approach is to increment the various speed parameters in small steps and observe the effect each change has on print quality. Travel speed is a safe starting point, and it is not unrealistic to attain speeds of up to 250mm/s (if your printer can handle it). Adjusting the speed of perimeters, infill is available in simple mode, and the general rule is to have the perimeter go a little slower than the infill in order to reduce possible blemishes on the surface (infill can be faster because slight gaps will not matter as much).

Expert mode offers more parameters to fine tune printer speeds. Differentiation between external, small and other perimeters, infill locations, and bridges and gaps are available, as well as the ability to slow down for the first layer.

¹¹<https://github.com/kliment/Printrun>

¹²<http://www.repetier.com/>

¹³<https://github.com/timschmidt/repsnapper>

3.4. EXPERT MODE

Speed for print moves		
Perimeters:	<input type="text" value="90"/>	mm/s
Small perimeters:	<input type="text" value="40"/>	mm/s or %
External perimeters:	<input type="text" value="70"/>	mm/s or %
Infill:	<input type="text" value="100"/>	mm/s
Solid infill:	<input type="text" value="100"/>	mm/s or %
Top solid infill:	<input type="text" value="50%"/>	mm/s or %
Support material:	<input type="text" value="60"/>	mm/s
Bridges:	<input type="text" value="60"/>	mm/s
Gap fill:	<input type="text" value="40"/>	mm/s

Speed for non-print moves		
Travel:	<input type="text" value="150"/>	mm/s

Modifiers		
First layer speed:	<input type="text" value="50%"/>	mm/s or %

Acceleration control (advanced)		
Perimeters:	<input type="text" value="0"/>	mm/s ²
Infill:	<input type="text" value="0"/>	mm/s ²
Bridge:	<input type="text" value="0"/>	mm/s ²
Default:	<input type="text" value="0"/>	mm/s ²

Figure 3.20: Expert mode speed options.

Where indicated a value can be given in percentage. This is in relation to the preceding value, e.g. 50% solid infill would be half of the value defined for infill.

A few general guidelines for each option:

- **Perimeters** - In expert mode this parameter can be increased slightly as the **External perimeters** option can be used to ensure blemish free external faces.
- **Small perimeters** - Meant for holes, islands and fine details, a slower speed here is recommended.
- **External perimeters** - A slightly slower value may ensure cleaner surfaces.
- **Infill** - As fast as you can without compromising the integrity of the fill structure. Faster extrusions can break and result in weak spots.
- **Solid infill** - The bottom of the model, and any additional solid layers is usually slightly slower than infill but faster than perimeters.

- **Top solid infill** - Allow time for the extrusion to cleanly cover the previous top layers and result in a tidy top surface. the last few layers should have bridged the infill structure nicely, preparing the way for a neat finish.
- **Support material** - Generally support structures are quick and dirty, and so long as the base is adequately supported they can be built as quickly as they can.
- **Bridges** - Having the extrusion span distances depends on the material and cooling. Going too slow will result in sagging, too fast will result in broken strands. Experimentation is the key here, but generally bridging runs slower than perimeters.
- **Gap fill** - Filling in small gaps results in the extruder quickly oscillating and the resulting shaking and resonance could have a detrimental affect on the printer. A smaller value here can guard against this. A setting of zero disables gap filling completely.
- **Travel** - As fast as your printer will allow in order to minimise ooze.
- **First layer speed** - As mentioned in section 3.3, the first layer is important to lay down correctly, and a slower pace helps enormously. Setting a value of 50%, or even less, can really help.

Acceleration control is an advanced setting allowing acceleration settings for perimeters, infill, bridge, as well as a default setting, to be made. Deciding which values to set depends on the capabilities of the machine. Any settings within the firmware may be a good starting point.

Take into account any restrictions enforced by the firmware as many have settings for the maximum safe speed of each axis.

Infill Patterns and Density

There are several considerations when choosing an infill pattern: object strength, time and material, personal preference. It can be inferred that a more complex pattern will require more moves, and hence take more time and material.

3.4. EXPERT MODE

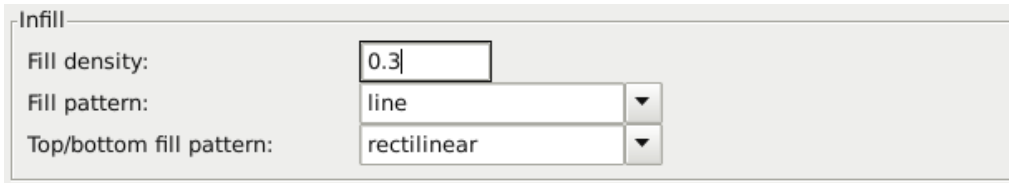

Figure 3.21: Infill pattern settings.

Slic3r offers several infill patterns, four regular, and three more exotic flavours. The numbers given in brackets below each figure are a rough estimate of material used and time taken for a simple 20mm cube model¹⁴. Note that this is only indicative, as model complexity and other factors will affect time and material.

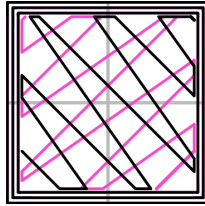

Figure 3.22: Infill pattern: Line (344.51mm / 5m:20s)

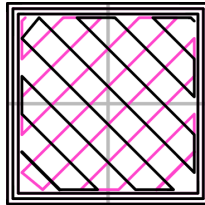

Figure 3.23: Infill pattern: Rectilinear (350.57mm / 5m:23s)

¹⁴Taken from <http://gcode.ws>

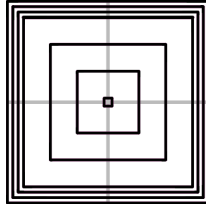

Figure 3.24: Infill pattern: Concentric (351.80mm / 5m:30s)

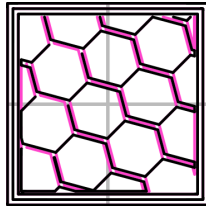

Figure 3.25: Infill pattern: Honeycomb (362.73mm / 5m:39s)

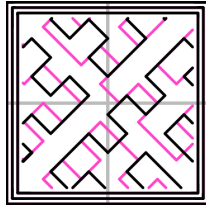

Figure 3.26: Infill pattern: Hilbert Curve (332.82mm / 5m:28s)

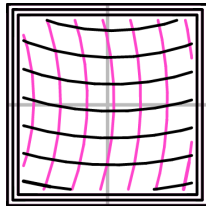

Figure 3.27: Infill pattern: Archimedean Chords (333.66mm / 5m:27s)

3.4. EXPERT MODE

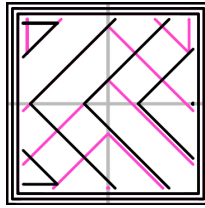

Figure 3.28: Infill pattern: Octagram Spiral (318.63mm / 5m:15s)

Certain model types are more suited for a particular pattern, for example organic versus mechanical types. Figure 3.29 shows how a honeycomb fill may suit this mechanical part better because each hexagon bonds with the same underlying pattern each layer, forming a strong vertical structure.

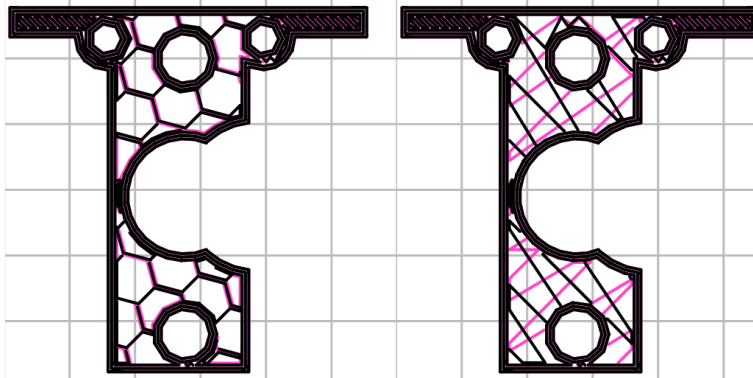

Figure 3.29: Infill pattern comparison in a complex object. Left to Right: honeycomb, line

Most models require only a low density infill, as providing more than, say, 50% will produce a very tightly packed model which uses more material than required. For this reason a common range of patterns is between 10% and 30%, however the requirements of the model will determine which density is best. Figure 3.30 shows how the patterns change as the density increases.

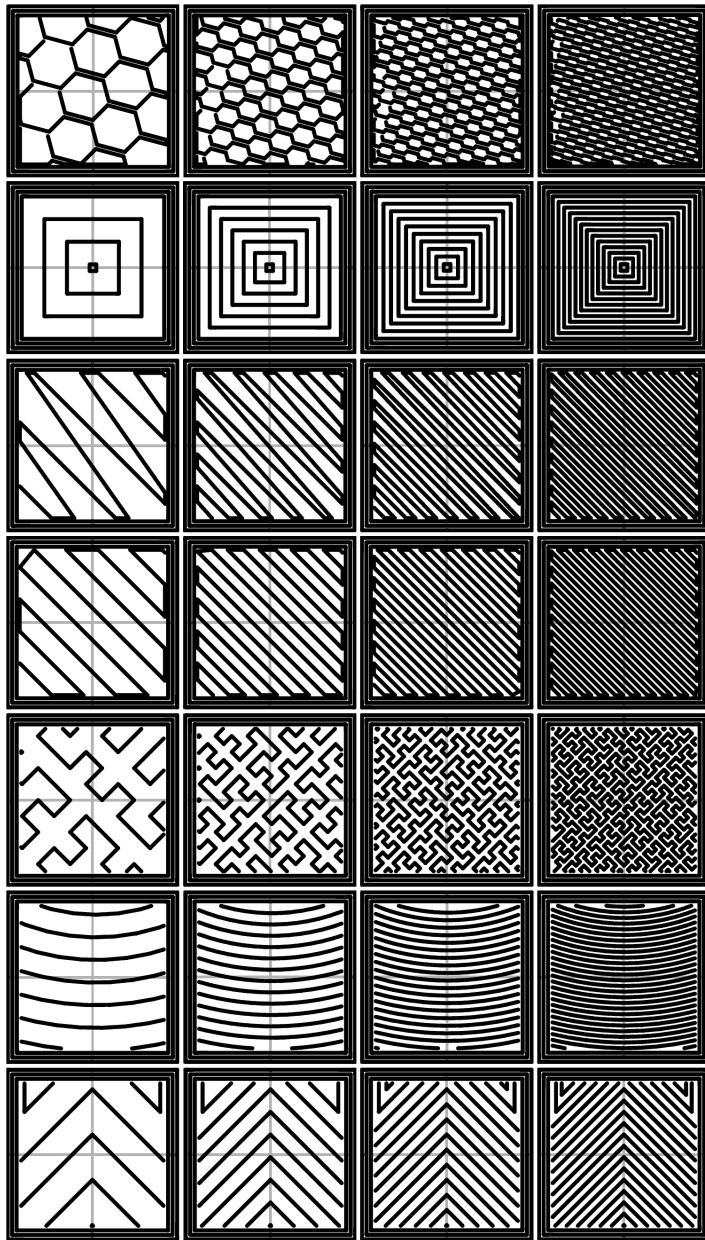

Figure 3.30: Infill patterns at varying densities. Left to Right: 20%,40%,60%,80%. Top to Bottom: Honeycomb, Concentric, Line, Rectilinear, Hilbert Curve, Archimedean Chords, Octagram Spiral

Infill Optimization

Slic3r contains several advanced infill settings which can help produce better extrusions.

Advanced

Infill every: 2 layers

Only infill where needed:

Solid infill every: 0 layers

Fill angle: 45 °

Solid infill threshold area: 70 mm²

Only retract when crossing perimeters:

Infill before perimeters:

Figure 3.31: Infill advanced settings.

- **Infill every n layers** - Will produce sparse vertical infill by skipping a set number of layers. This can be used to speed up print times where the missing infill is acceptable.
- **Only infill where needed** - Slic3r will analyse the model and choose where infill is required in order to support internal ceilings and overhangs. Useful for reducing time and materials.
- **Solid infill every n layers** - Forces a solid fill pattern on the specified layers. Zero will disable this option.
- **Fill angle** - By default the infill pattern runs at 45° to the model to provide the best adhesion to wall structures. Infill extrusions that run adjacent to perimeters are liable to de-laminate under stress. Some models may benefit from rotating the fill angle to ensure the optimal direction of the extrusion.
- **Solid infill threshold area** - Small areas within the model are usually best off being filled completely to provide structural integrity. This will however take more time and material, and can result in parts being unnecessarily solid. Adjust this option to balance these needs.

- **Only retract when crossing perimeters** - Retracting, to prevent ooze, is unnecessary if the extruder remains within the boundaries of the model. Care should be taken if the print material oozes excessively, as not retracting may result in enough material loss to affect the quality of the subsequent extrusion. However, most modern printers and materials rarely suffer from such extreme ooze problems.
- **Infill before perimeters** - Reverses the order in which the layer is printed. Usually the perimeter is laid down initially, followed by the infill, and this is usually the preferable as the perimeter acts as a wall containing the infill.

Fighting Ooze

Unless the material being extruded has a very high viscosity it will ooze from the nozzle in between extrusions. There are several settings in Slic3r to which can help to remedy this.

The retraction settings, found in the **Printer** tab, tell the printer to pull back the filament between extrusion moves. This can alleviate the pressure in the nozzle, thus reducing ooze. After the subsequent travel move the retraction is reversed to prepare the extruder for the next extrusion.

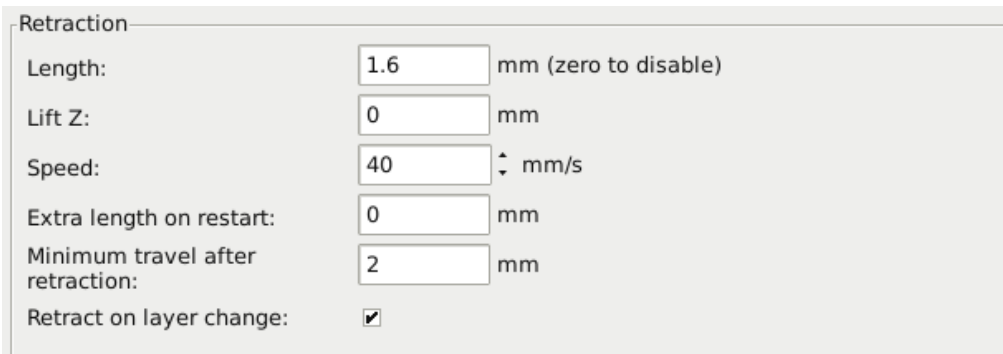

The image shows a screenshot of the 'Retraction' settings panel in Slic3r. The panel has a title bar 'Retraction' and contains the following settings:

Length:	<input type="text" value="1.6"/>	mm (zero to disable)
Lift Z:	<input type="text" value="0"/>	mm
Speed:	<input type="text" value="40"/>	mm/s
Extra length on restart:	<input type="text" value="0"/>	mm
Minimum travel after retraction:	<input type="text" value="2"/>	mm
Retract on layer change:	<input checked="" type="checkbox"/>	

Figure 3.32: Retraction settings.

- **Length** - The number of millimeters to retract. Note that the measurement is taken from the raw filament entering the extruder. A value of between 1 and 2mm is usually recommended. Bowden

3.4. EXPERT MODE

extruders may need up to 4 or 5mm due to the hysteresis introduced by the tube.

- **Lift Z** - Raises the entire extruder on the Z axis by that many millimeters during each travel. This can be useful to ensure the nozzle will not catch on any already laid filament, however it is usually not necessary and will slow the print speed. A value of 0.1mm is usually sufficient.
- **Speed** - The speed at which the extruder motor will pull back the filament. The value should be set to as quick as the extruder can handle without skipping steps, and it is worth experimenting with this value to find the quickest retraction possible.
- **Extra length on restart** - Adds an extra length of filament after the retraction is compensated after the travel move. This setting is rarely used, however should the print show signs of not having enough material after travel moves then it may be useful to add a small amount of additional material.
- **Minimum travel after retraction** - Triggering a retraction after very short moves is usually unnecessary as the amount of ooze is usually insignificant and it slows down the print times. Set the number of millimeters minimum distance the nozzle must move before considering a retraction. If the printer handles ooze well this can be increased to 5 or 6mm.
- **Retract on layer change** - Movement along the Z axis must also be considered when dealing with oozing, otherwise blobs may occur. It is recommended to leave this setting on.

Additionally there are several settings in the **Print** tab which can help control oozing.

- **Only retract when crossing perimeters (Infill)** - Tells Slic3r to only retract if the nozzle will cross the threshold of the current island being extruded. Slight ooze within the walls of a part are not seen and can usually be accepted.

- **Avoid crossing perimeters** (Layers and perimeters - Advanced)
 - Will force the nozzle to follow perimeters as much as possible to minimise the number of times it must cross them when moving around, and between, islands. This has a negative impact on both G-code generation and print times.
- **Randomize starting points** (Layers and perimeters - Vertical shells)
 - As the extruder moves up to the start of the next layer any ooze can result in blobs. If the same start point is used for every layer then a seam can form the length of the object. This setting will move the start point to a difference location for each layer.

Skirt

The **Skirt** setting adds an extrusion a short distance away from the perimeter of the object. This can ensure that the material is flowing smoothly from the extruder before it starts on the model proper.

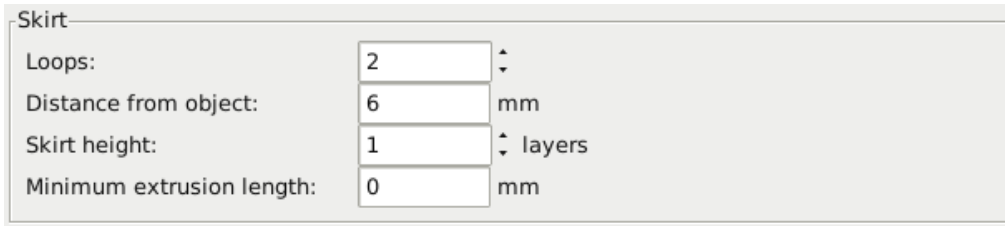

Skirt	
Loops:	2 <input type="text"/>
Distance from object:	6 <input type="text"/> mm
Skirt height:	1 <input type="text"/> layers
Minimum extrusion length:	0 <input type="text"/> mm

Figure 3.33: Skirt settings.

- **Loops** - How many circuits should be completed before starting on the model. One loop is usually sufficient.
- **Distance from object** - The millimeters between the object and the skirt. The default of 6mm is usually sufficient.
- **Skirt height** - The number of layers to lay down a skirt for. For ensuring the material is flowing smoothly, one layer is sufficient, however the skirt function can also be used to build walls around the object in case it should be protected from drafts.

3.4. EXPERT MODE

- **Minimum extrusion length** - Dictates a minimum number of millimeters that the skirt should be, should the loop around the object not be enough.

Cooling

Temperature plays a key part in determining print quality. Too hot and the material deforms, too cool and layer adhesion may be problematic. Applying cooling will allow the freshly deposited material to solidify enough to provide a good base for the next layer, helping with overhangs, small details and bridges.

There are two main techniques for cooling: adding a fan and slowing down the print speed. Slic3r may choose to use both techniques, using a fan first, and then slowing down the print if the layer time is too fast.

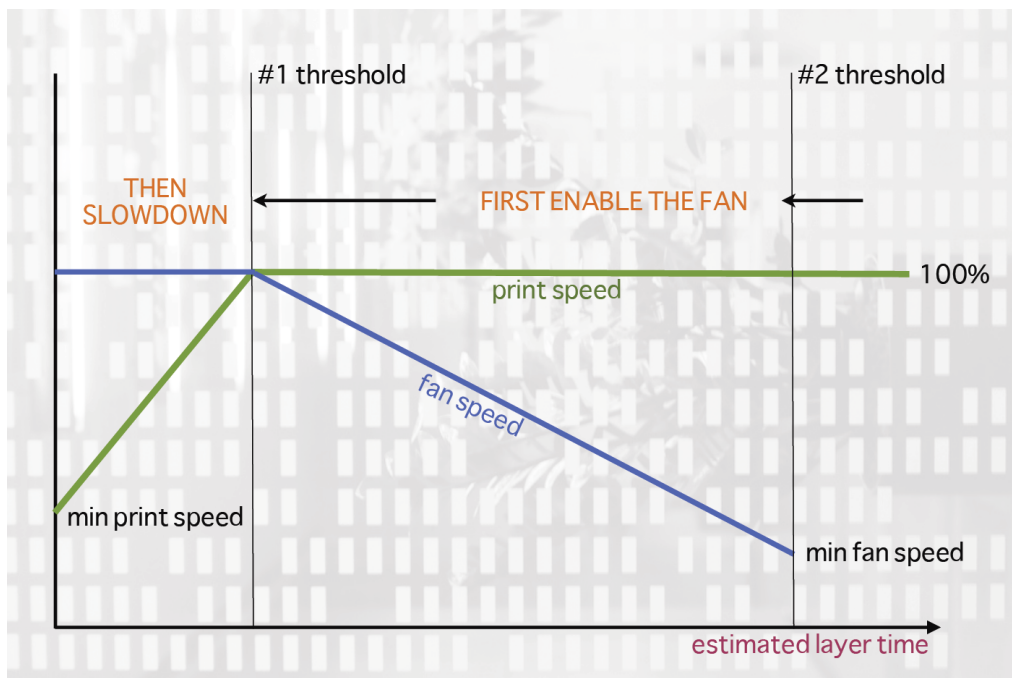

Figure 3.34: Cooling strategy.

Figure 3.34 shows the strategy adopted by Slic3r. Reading from right to left, when the minimum fan threshold (#2) is reached the fan is turned

on. This increases in intensity as the layer time decreases. The print speed remains constant until the estimated print time drops below a certain threshold (#1), this is when the print speed is reduced until it reaches it's minimum value.

Fans

Most electronics and firmware allow the addition of a fan via a spare connector. These can then be instructed with G-code, from Slic3r, to turn on or off as the model requires, and to rotate at different speeds.

Care should be taken with the positioning of the fan so that it does not cool any heated bed more than necessary. It should also not cool the heater block of the hot-end so as not to force it to do more work and waste energy. The air movement should aim for the nozzle tip, flowing over the freshly extruded material.

A duct may help in guiding the flow correctly, and there are several designs available online, for a wide variety of printers.

Slowing Down

Slic3r can tell the printer to slow down if the estimated layer time is above a certain threshold.

Care must be taken as the intended effect could be mitigated by the nozzle not moving far enough away from the fresh extrusion, a problem with small, detailed layers. For this reason it is usually recommended to use a fan where possible.

Configuring

In simple mode Slic3r will attempt to choose the optimal settings for both fans and speed. Expert mode gives more granular options.

3.4. EXPERT MODE

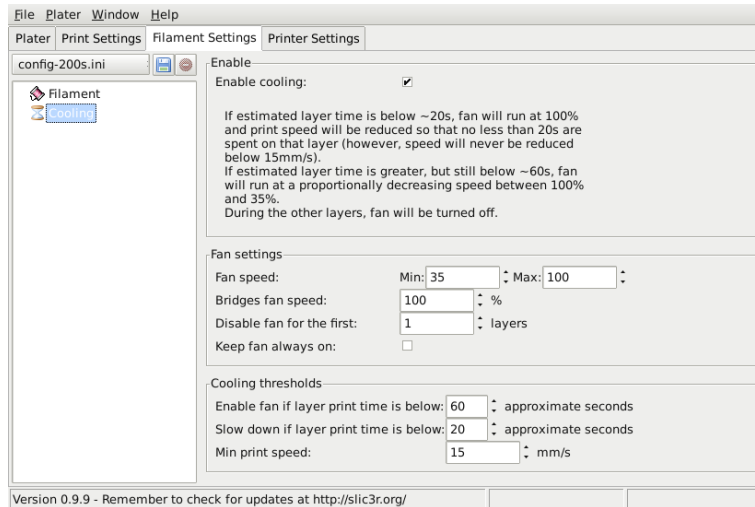

Figure 3.35: Cooling advanced settings.

- **Fan speed** - Determines the minimum and maximum speeds - useful for fans that run too fast by default.
- **Bridges fan speed** - As the material stretches over wide gaps, it makes sense to try and cool it as much as possible, therefore a full fan speed is recommended.
- **Disable fan for first x layers** - Section 3.3 detailed how important the first layer is, and so it makes sense not to apply the fan until sure the print is securely attached to the bed. Keeping the fan turned off for the first two or three layers is a good idea.
- **Keep fan always on** - Overrides any other choices and has the fan run continuously, at least at the minimum speed setting. This can be useful when printing with PLA, but is not recommended for ABS.
- **Enable fan if print time is below t seconds** - Triggers the fan if the layer will be completed within the given number of seconds.
- **Slow down if layer print time is below t seconds** - Slows down the print if the layer will be completed within the given number of seconds.
- **Min print speed** - A lower limit on how slowly a layer can be printed.

Support Material

Generally, most 3D models will print with overhanging parts by up to a certain degree. The angle is determined by several factors, most notably layer height and extrusion width, and is usually around 45° . For models with larger overhangs a support structure may have to be printed below it. This incurs the use of more material, longer print times, and post printing clean-up.

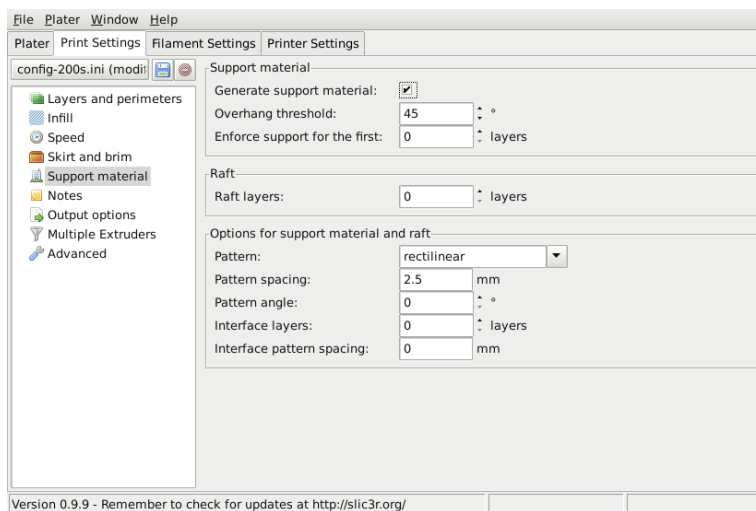

Figure 3.36: Support structure options.

The first thing to do is activate the support material option. Providing a value of zero to the **Overhang threshold** parameter tells Slic3r to detect places to provide support automatically, otherwise the degrees given will be used. Support generation is a relatively complex topic, and there are several aspects which determine the optimal support, it is strongly recommended to set the threshold to zero and allow Slic3r to determine the support required.

Small models, and those with small footprints, can sometimes break or detach from the bed. Therefore the **Enforce support** option will cause support structures to be printed for the given number of layers, regardless of the angle threshold value.

To demonstrate the infill patterns the minimug model was tilted by 45° along the x axis, as shown in figure 3.37.

3.4. EXPERT MODE

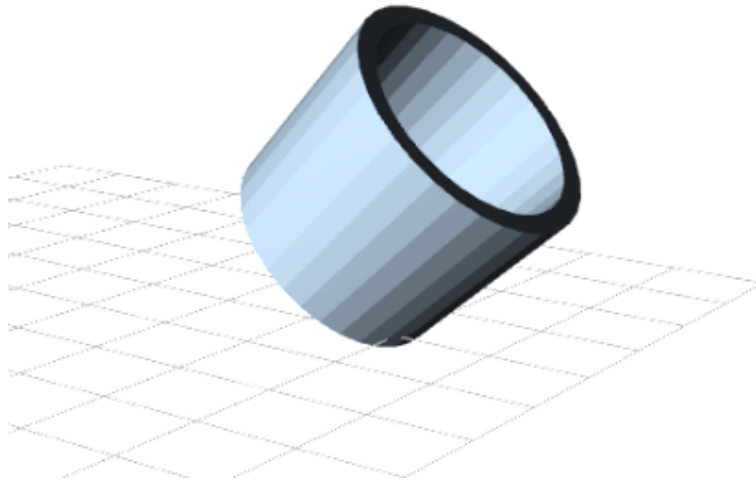

Figure 3.37: Minimug model, tilted 45°.

As with infill, there are several patterns available for the support structure.

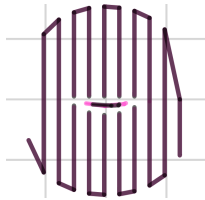

Figure 3.38: Support infill pattern: Rectilinear

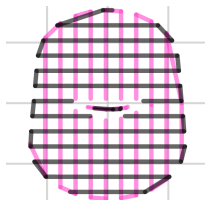

Figure 3.39: Support infill pattern: Rectilinear Grid

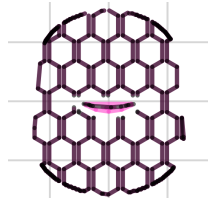

Figure 3.40: Support infill pattern: Honeycomb

Pattern Spacing determines the distance between support lines, and is akin to infill density apart from being defined only in mm. If changing this attribute take into account the width of the support extrusion and the amount of support material that will adhere to the object.

Care should be taken to choose a support pattern which matches the model, where the support material attaches perpendicularly to the wall of the object, rather than in parallel, so it will be easy to remove. If the support structure does run along the length of a wall then the **Pattern Angle** option allows the direction of the support lines to be rotated.

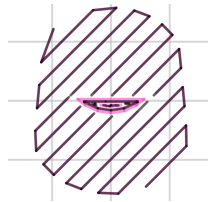

Figure 3.41: Example of pattern angle rotated 45°.

3.5 Configuration Organization

There are two ways in which to organize the configuration settings: exporting and importing the configuration settings, and profiles. The former is available in both simple and expert mode, whereas profiles is only available in expert mode.

Exporting and Importing Configuration

The current set of configuration options can be simply exported via the **Export Config File** menu option. This saves all the values into a text file

3.5. CONFIGURATION ORGANIZATION

with a `.ini` extension. Previously saved files can be loaded with the **Load Config** menu option.

This gives a rudimentary means to store different configuration settings for different needs. For example a set with slightly faster print speeds, or a different infill pattern. However this way of organizing things will quickly become frustrating, as each minor change to a parameter may have to be duplicated across many configurations. For this reason, profiles are a more suitable way of managing multiple configurations.

This method also allows configuration to be transferred between machines, or stored remotely.

Profiles

After a few prints it will become apparent that it is worth having a set of configuration options to choose from, and that some parameters change at different rates as others. In expert mode, profiles can be created for Print, Filament and Printer settings, with the expectation that the printer settings change least often, filament rarely, and the print settings could be changed for each model. These different profiles can be mixed and matched as desired, and can be selected either in their respective tabs, or directly from the plater.

Creating Profiles

Open the desired tab and change the settings as necessary. Once satisfied, click the save icon to the left above the setting titles, and give a suitable name when prompted.

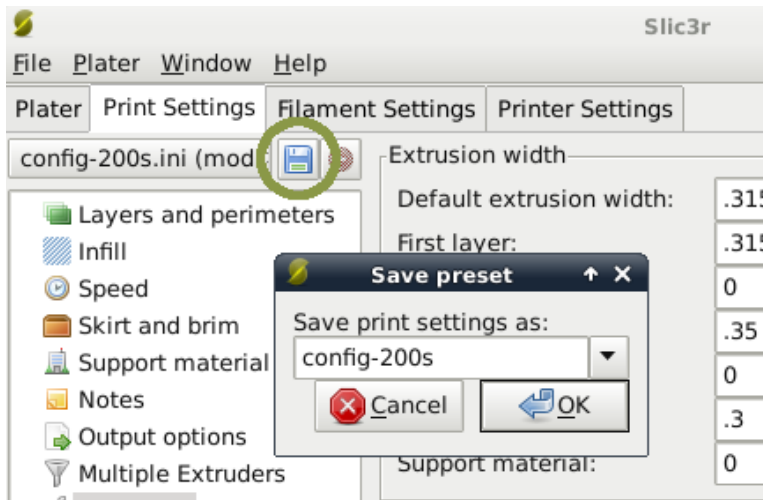

Figure 3.42: Saving a profile.

Profiles can be deleted by choosing the profile to delete and clicking the red delete button next to the save button.

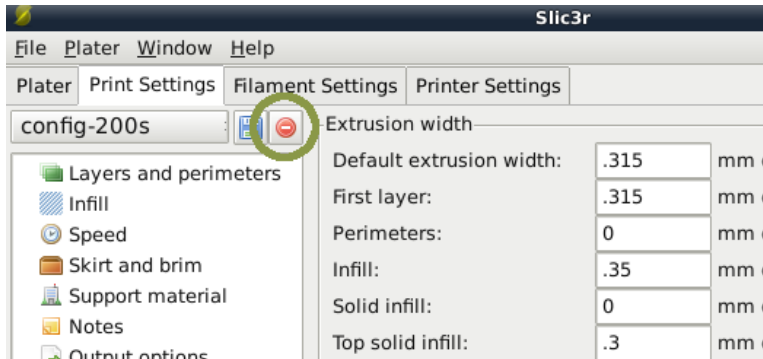

Figure 3.43: Deleting a profile.

3.6 The Cutting Edge of Slicer

Building from Source

Follow these steps to build from source.

```
$ git clone git://github.com/alexrxj/Slic3r
```

3.6. THE CUTTING EDGE OF SLICER

```
$ cd Slic3r  
$ sudo perl Build.PL  
$ sudo cpan Wx
```

Loading Print Material

Loading Print Material

Before you start printing you will need to load a reel of filament on to the reel holder. If mounted correctly the reel holder will keep the filament reel rotating smoothly. The reel holder is meant to work with 1kg and 5lb plastic filament reels but can be modified to work with other reel and spool types.

1. Locate the filament reel spindle and unthread and remove the wing nut and washer (fig. 4.1, page 88). Set the filament reel on to the rear reel mount with the filament feeding counter clockwise. Insert the reel spindle into the plastic filament reel.

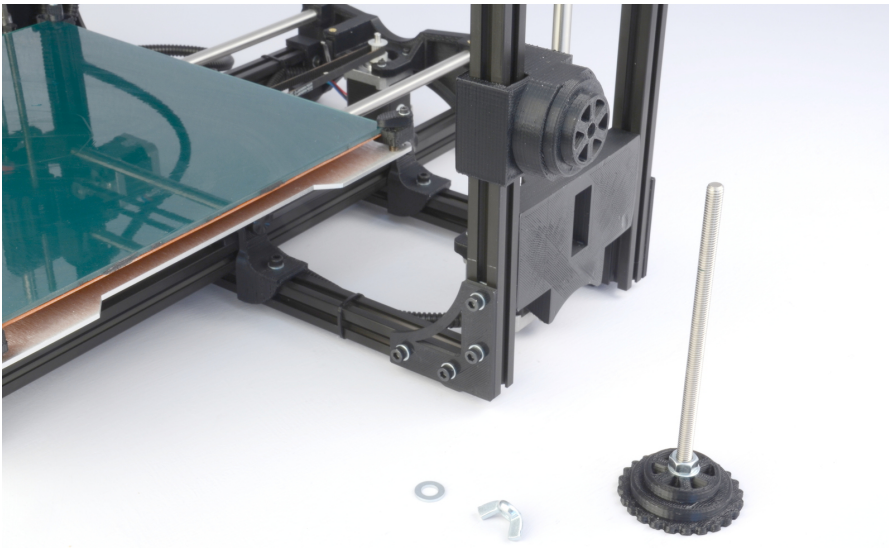

Figure 4.1: Filament spool mount parts

2. Thread the reel spindle through the reel into the rear reel mount on the lower right hand side of the TAZ 3D Printer (fig. 4.2, page 89). Turn the spindle handle clockwise until it snugs up against the reel and then turn it back one quarter of a turn. This will allow the reel to easily turn but not turn too freely that it would allow the filament to unravel.
3. Slide the washer onto the end of the spindle on the back of the reel mount. Thread the wing nut onto the spindle end and loosely up

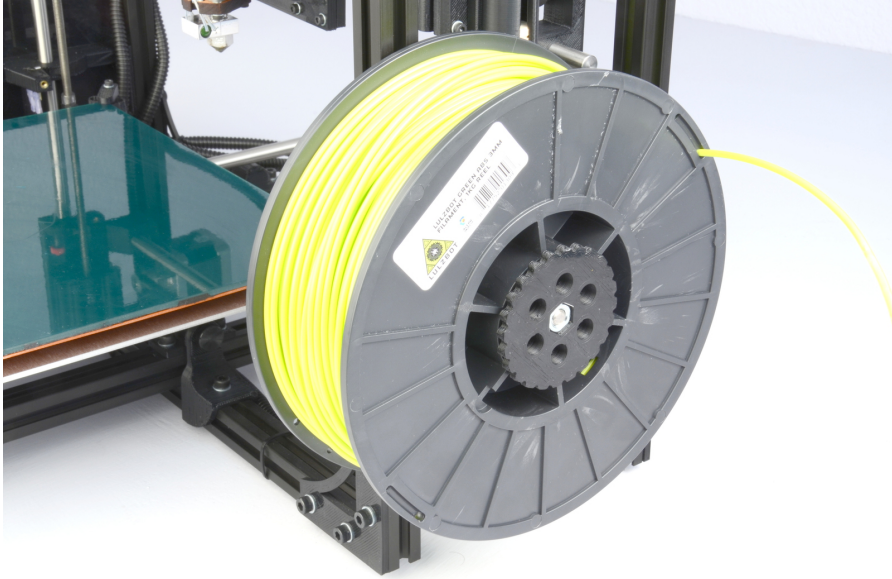

Figure 4.2: Filament spool mount front

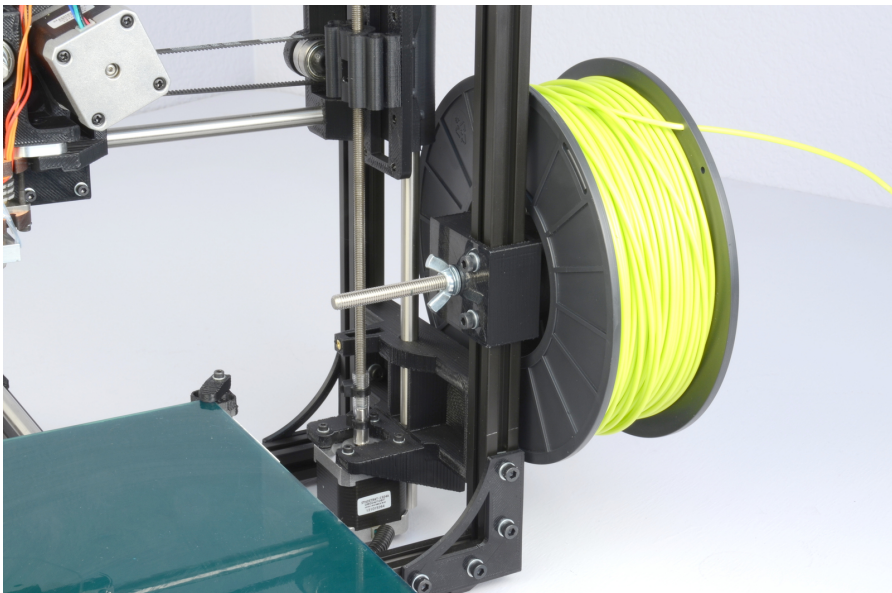

Figure 4.3: Filament spool mount back

Loading Print Material

against the nut on the back of the reel mount (fig. 4.3, page 89). While holding the reel spindle handle in place tighten the wing nut against the nut on the back of the reel mount. This will keep the tension you set at the handle in place. If you need to adjust the tension, loosen the wingnut, adjust the handle tension, and retighten the wingnut.

4. Feed the end of the filament through the filament feed tube. The Filament should now be threaded through the PTFE sleeve and exiting near the extruder (fig. 4.4, page 90).



Figure 4.4: Filament run through the guide

5. When changing filament, slide the opposite end of the filament through one of the holes in hub of the filament reel. This will keep the filament from unwinding from the reel (fig. 4.2, page 89).

Your First 3D Print

5.1 Set Temperature

Make sure to first read the instructions for using the Printrun software. Connect to the printer as described in the Printrun software section (page 30). Set the hot end and print surface for ABS or PLA plastic and turn both on. The temperature settings for ABS should be set at 230°C for the hot end and 85°C for print surface; for PLA they should be set at 180°C-185°C for the hot end and 60°C for print surface. If you have not already, make sure the axes end stops are aligned to be triggered when each axis homes. Click the **Motors Off** button.

5.2 Inserting Filament Into the Extruder

Once the hot end is heated to the correct temperature you will now need to load the plastic filament into the extruder. Raise both the idler clip and the 2 screws adding tension to release the hinged idler. It can be loosened if necessary. (Fig. 5.1). Gently pull both the idler screws and the plastic clip

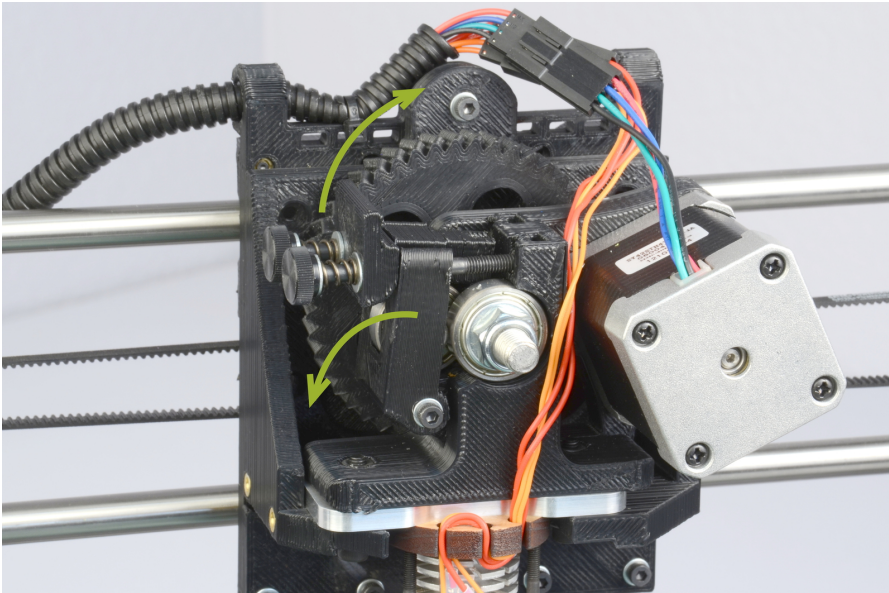

Figure 5.1: Extruder idler release

upwards to release the idler. The idler can be rotated downwards allowing

5.3. HOME PRINTER

access to the hobbed bolt and filament feed hole(Fig. 5.2, page 93). Feed the end of the plastic filament into the filament feed hole (Fig. 5.2). Now you

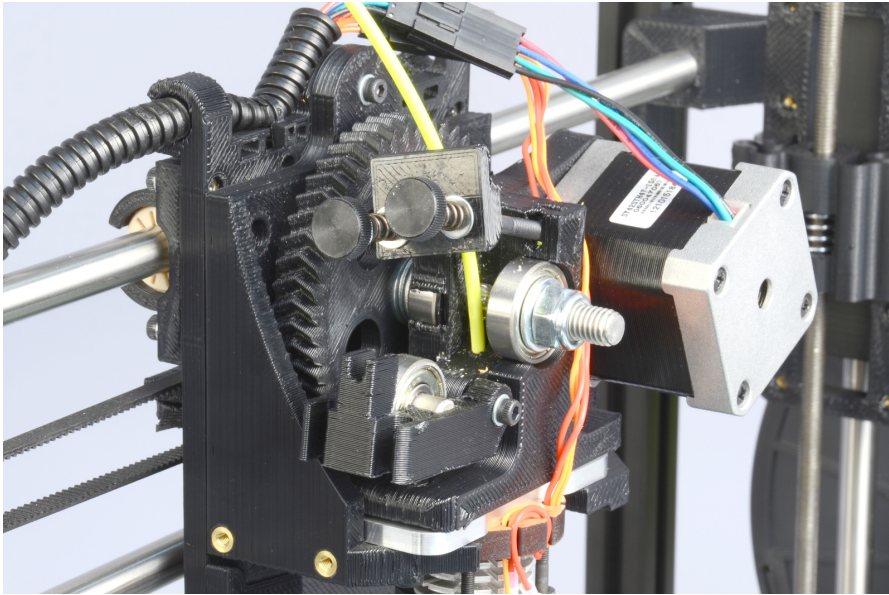

Figure 5.2: Extruder filament slot

can push the filament through the extruder by slowly pushing the filament down into the hot end.

Once the filament extrudes a small amount out of the nozzle raise the idler and slide the two idler bolts and plate back into place. Tighten the two idler bolts if you previously loosened them or if you need additional clearance. Now use the **Extrude** button in Printron to test that the extruder is working properly. You may need to extrude 30-60mm to fully prime the hot end.

5.3 Home Printer

Use the home buttons to home the X axis and then the Y axis. Next home the Z axis. When the Z axis is at home the nozzle tip should be sitting right against the glass (Fig. 5.3, page 94). The image to the right, in figure 5.3, is the correct nozzle height. The nozzle should not be pushing down on the print surface. To lower or raise the Z home height adjust the Z end stop

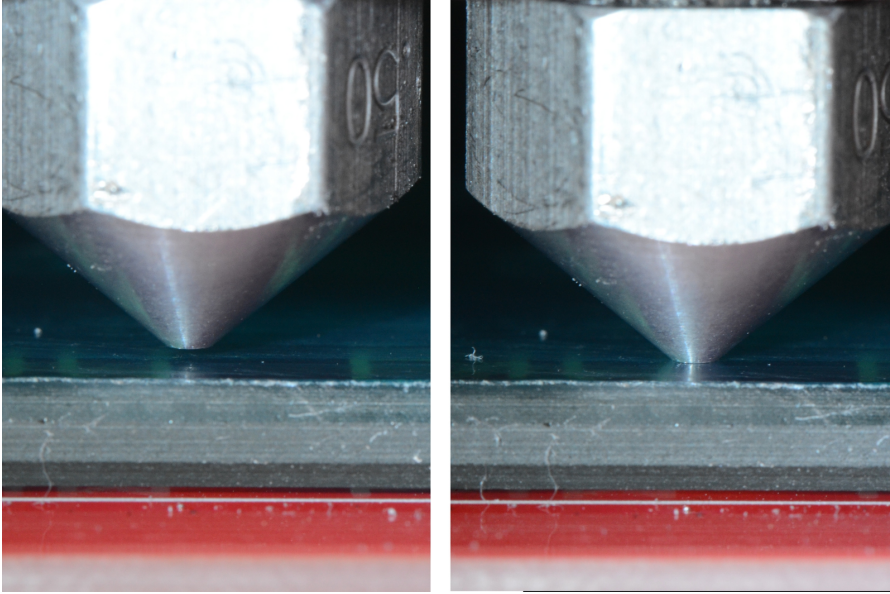

Figure 5.3: Nozzle height

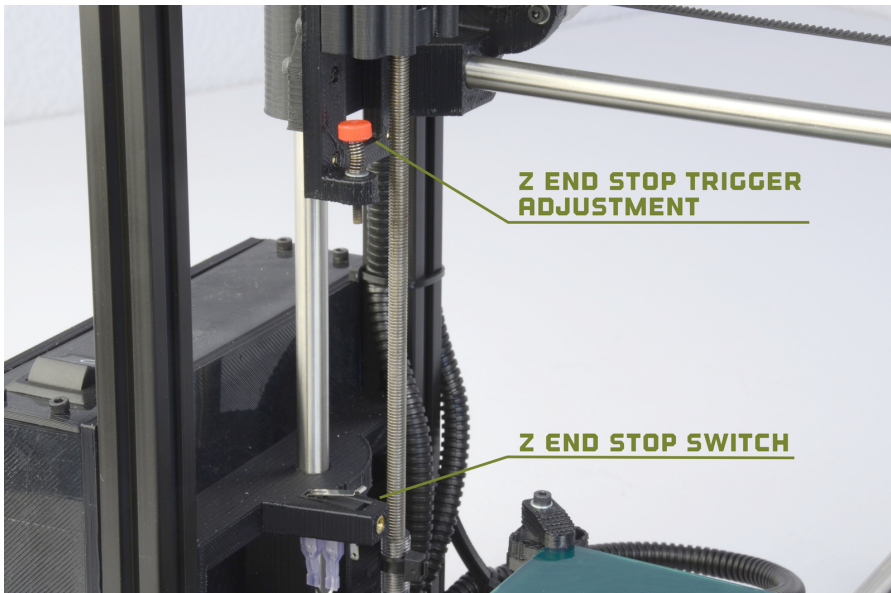

Figure 5.4: Z end stop trigger

5.4. Z PRINT HEIGHT

trigger. The red end stop trigger is on the far left of the printer mounted on the X-axis motor mount. (Fig. 5.4, page 94). The Z home position can be raised by turning the Z end stop trigger clockwise and lowered by turning counter-clockwise. Once you have homed the axes and the hot end and bed have reached the correct temperature it is time to print!

5.4 Z Print Height

Load the `bedcalib.gco` file. This file can be found at: <http://download.lulzbot.com/TAZ/objects/calibration/bedcalib.gco>

The `.gcode` pattern should appear in the Printron G-Code viewer. Press the **Print** button to begin the print. When the print starts make sure the first layer is not printing too close or too far from the print bed. Note Figure 5.5, page 95, as an example of a good first layer adhesion. From left to right:

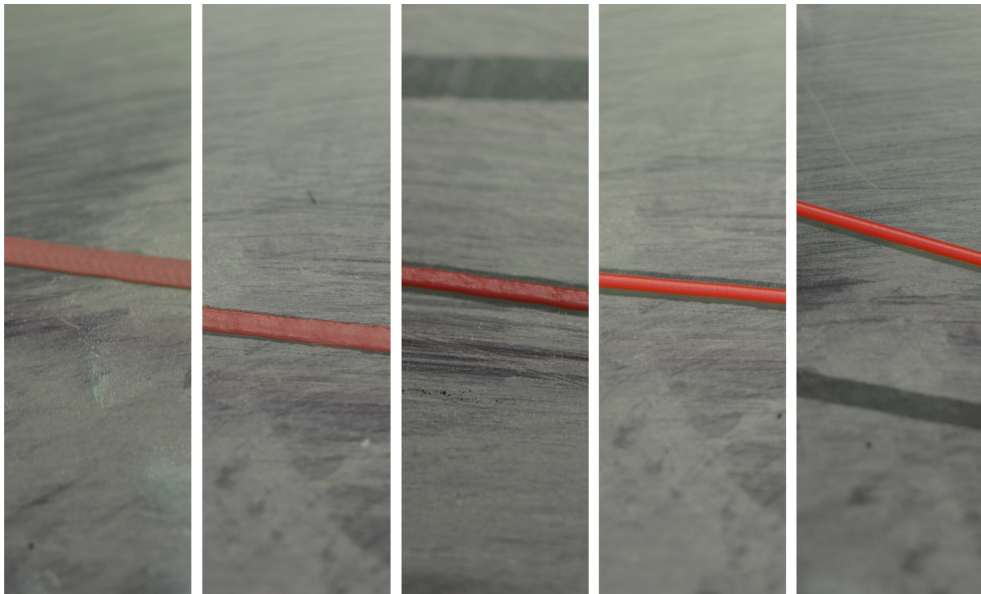

Figure 5.5: First layer adhesion

very low, low, *perfect*, high, very high. If the first layer is too high or low you can pause the print by pressing the **Pause** button. Adjust the Z end stop trigger. After making adjustments you can home the axes and press **Restart** to restart the print.

5.5 Remove Part

After the part is finished printing, the heated bed will automatically cool down to 0°C. Once the bed cools you can pop the finished part off of the printed surface. To remove the printed part, use the clam knife included in your printer kit. Leather gloves are suggested to protect your hands from the clam knife blade. It is also safe practice to not place your hand behind the direction you are pushing the clam knife. Using the side of the clam knife blade pry up one side of the printed part. If your part is large you may need to pry at multiple points to pop the part off of the print surface. When removing parts take caution to not damage the PET film. If the film is cut or ripped it will peel from the glass and need to be replaced. Make sure to reset the heated bed to the correct temperature and allow it to heat up to the needed temperature before starting the next print.

Maintaining Your 3D Printer

6.1 Overview

There is little maintenance needed in keeping your TAZ 3D printer running. Depending on your rate of use you will want to perform a quick check of your printer every 2-4 weeks. The following maintenance guide lines will keep your printer printing quality parts.

6.2 Smooth Rods

Wipe the smooth steel rods with a clean rag or paper towel. The linear bushings leave a solid lubricant that builds up over time. If you begin hearing squeaking noises while the printer is printing, this is likely a sign that the smooth rods need to be cleaned. NOTE: never apply any lubricant or cleaning agent to the smooth rods; the bushings are self lubricating.

6.3 PET Sheets

After repeated use, the PET sheet print surface will begin to wear. Replacement PET sheets are available on LulzBot.com. To replace the PET print surface it is best to remove the glass and heater assembly from the bed mount. Disconnect the two connectors from the left of the print bed. Locate the four bed finger clamps, one for each corner of the glass. Turn each finger 90 degrees and then lift up and out the glass and heater assembly. Place the assembly on a flat clean surface. Take caution to never push down hard on the glass as this can cause the glass bed to crack.

Peel off the worn PET sheet from the glass print surface. If there is any glue or plastic residue left on the glass surface, clean it with acetone or an alcohol based glass cleaner. Peel a corner of the clear plastic away from the green PET sheet and apply the corner of the PET to the corner of the glass. Align the PET sheet onto the glass. Using a paper towel begin slowly smoothing/applying the PET onto the glass while pulling back the clear sheet from underneath the PET. You can also spray glass cleaner onto the paper towel or the top side of the PET for a smoother application. After applying the PET sheet to the glass any bubbles can be pushed out or smoothed down using a credit card or stiff and dull piece of plastic.

Once the new PET sheet is in on, place the glass and heater assembly back into the bed mount. With the glass assembly back in place, turn the

bed finger clamps back onto the corners of the glass sheet to lock it in place. Reconnect the two connectors to the left of the print bed.

6.4 Hobbed Bolt

The plastic filament is pulled through the extruder by a hobbed bolt. After repeated use, the teeth of the hobbed bolt can become filled with plastic. Using the brush or pick from the printer kit, clean out the hobbed bolt teeth. If an extruder jam ever occurs, remove the plastic filament from the extruder and clean out the hobbed bolt.

6.5 Software

Every quarter LulzBot will release a new stable version of the software. It is best to update the software every time a new version is released. The software is as important in printing quality parts as the hardware. Each quarterly software update can bring advances in print quality. The files are available at <http://download.lulzbot.com/TAZ/> . You can also find updated software versions in the Support/Downloads section of LulzBot.com.

6.6 Belts

Over long periods or after extensive relocating of the printer you may need to re-tighten the belts on the TAZ 3D printer. For the X axis, using the 2.5mm hex driver, loosen one of the belt clamps. The belts clamps are located on the X axis carriage. To loosen the belt clamp, loosen the M3 screws on each side of the clamp. Using the needle nose pliers, pull the belt tight. While holding the belt tight, tighten down both M3 screws. The Y axis belt can be tightened in the same steps as the X axis with the belt clamps found on the bottom of the Y axis plate. Make sure not to over tighten the belts as this can cause unneeded stress on the printer.

6.7 Hot End

The hot end should be kept clean of extruded plastic by removing melted plastic strands with the tweezers. If melted plastic builds up on the hot end nozzle it can be cleaned with a paper towel soaked with acetone. Make sure the hot end is completely cool before attempting to clean the nozzle with acetone.

6.8 Electronics

The electronics case holding the RAMBo board may need to have dust blown out occasionally. Power down the printer and use the provided 2.5MM driver to remove the 4 M3 screws holding the lid to the enclosure. **The fan is mounted to the lid and connected to the RAMBo board. Be careful with the fan cable during removal.** Once removed use short bursts of compressed air to blow out any dust or debris. Plug in the lid fan paying attention to polarity and reattach the lid.

Advanced Usage

7.1 Intro

After becoming familiar with printing with the TAZ 3D printer with the default settings there are a few advanced techniques that may help in getting better and more consistent prints. Some of these instructions include items and materials not included with the TAZ. With any of these additional items or materials, follow safety and usage guidelines as instructed by the manufacturer.

7.2 Changing nozzles

The TAZ 3D printer ships with a standard 0.35mm nozzle which allows small layer resolution and up to 0.35mm layers. Although the 0.35mm nozzle will be perfect for most printing applications LulzBot also offers smaller and larger nozzle sizes.

If you have already printed with your Budaschnozzle you will need to loosen the nozzle after the hot end has reached 160C. Unless heated past 160°C, any ABS/PLA on the threads will influence how easily the items can be moved. Removing the nozzle with the hot end cold, with the presence of plastic on the threads can potentially damage the nozzle threads/threaded extension

When re-installing the nozzle, slightly thread the nozzle onto the threaded extension, only one thread then set the hot end temperature to 160C. Once the hot end has reached 160C finish installing the nozzle. **Take extreme caution when handling the hot end when at high temperatures; when at 160C the hot end can cause severe burns. Use a pair of pliers or thick leather gloves when handling the hot end when at extrusion/melt temperatures. If your hot end has not been used the nozzle can be removed with the hot end at room temperature.**

To change the nozzle you will need an 18mm and 13mm wrench. Slide the 18mm wrench onto the rectangular aluminum heater block away from the heater resistor and thermistor wires.

Using the 13mm wrench turn the nozzle counter clock-wise. Make sure the nozzle is turning off of the threaded aluminum extension that runs up through the heater block. Do not allow the heater block to turn. This can put strain on and possibly damage the wiring.

7.3. ABS/ACETONE GLUE

Once you have removed the nozzle you can then thread on the other nozzle size you would like to use. Make sure the nozzle has threaded correctly onto the threaded extension before trying to turn it with the wrench. Turn the nozzle clock-wise until it tightens against the heater block.

After installing the new nozzle you may need to adjust your Z home trigger setting before printing again. Refer to the Printing Your First Print section (page 91) for calibrating the Z home trigger setting.

If you will be changing nozzles frequently we suggest reapplying a small amount of high temperate anti-seize to the inside threads of the nozzles. You will need an anti-seize capable of temperature of at least 250°C.

7.3 ABS/Acetone Glue

Acetone is not included or required with the TAZ 3D printer. An acetone safety label is included for the HDPE bottle.

Acetone can cause skin irritation when prolonged skin contact occurs. It is recommended to use acetone safe gloves when applying the ABS/acetone glue. Use the ABS/acetone glue in a well ventilated space. Leave the mixture bottle closed except when applying a small amount to the wiping towel. Acetone liquid and vapors are highly flammable. Keep acetone away from open flames and high temperature sources, including the 3D printer. Read the warnings label on your purchased acetone packaging for additional warnings.

You may find that during printing, printed parts lift off of the print surface on the corners. If you are seeing this problem you can make an ABS/acetone glue to apply to the print surface. Using the HDPE acetone safe bottle included in the printer kit, fill the bottle 3/4 full with acetone. Now cut eight, 75mm lengths of ABS filament and put them in the bottle with the acetone. Allow the ABS filament to dissolve for 4-6 hours.

When applying the acetone/ABS mixture it will work best when the bed temperature is below 60C. To apply the acetone/ABS mixture put a small amount onto a paper towel. Now, rub the towel onto the cool PET print surface to apply a *thin* layer of ABS. Generally only one thin layer of the acetone/ABS solution is needed. However, if needed you can apply multiple coats.

Hardware and Software Source Code

The LulzBot™ TAZ 3D printer is a free/libre hardware design. All of the source files are available at <http://download.lulzbot.com/TAZ> including:

- The latest version of this document, with L^AT_EX source code.
- 3D models and print files for all of the printed parts in `.stl`, `.gcode`, and other original source files.
- 3D calibration objects and random novelties.
- Production file for calculating large print runs.
- Design files for all electronics and machined parts.
 - Budaschnozzle hot end
 - RAMBo electronics
 - Various spec sheets
- Bill of materials including every part needed to build the printer.
 - TAZ
 - Budaschnozzle
- Drawings of components.
 - Aluminum extrusions
 - Budaschnozzle
 - Bed plate
- Software binaries and source code for GNU/Linux and others. Also includes known good configuration files.
 - Slic3r
 - Printron
 - Marlin

3D Printer Support

9.1 LulzBot

For common technical support questions for your TAZ 3D printer please visit lulzbot.com/support. Also, visit forum.lulzbot.com for support and tips from the LulzBot community. If you have further questions, e-mail our support team at support@lulzbot.com. Please completely read this manual before contacting for support questions or help. The latest version of this information guide is also available at <http://download.lulzbot.com>. You can also find more information including images, videos, and updated versions of this manual in the Support section of LulzBot.com.

9.2 Community

Community Support and Resources

- LulzBot forum: forum.lulzbot.com
- IRC chat rooms on the irc.freenode.net server.
 - **#reprap**: Highly active community chat room where help can easily be found
 - **#slic3r**: Slic3r chat room where Slic3r developers and users can give help
- RepRap.org forums: forums.reprap.org

Contact Information

10.1 Support

Email: support@LulzBot.com

Phone: +1-970-377-1111 x610

10.2 Sales

Email: sales@LulzBot.com

Phone: +1-970-377-1111 x600

10.3 Websites

Aleph Objects, Inc., the makers of LulzBot 3D Printers:

www.AlephObjects.com

LulzBot 3D Printers and parts:

www.LulzBot.com forum.LulzBot.com

INDEX

A

ABS, 103
acetone, 98, 100, 103
advanced techniques, 102
aluminum extrusions, 106
anti-seize, 103
Apple OS X, 28, 35, 36
axes, 33

B

baud rate, 31
bed plate, 106
belts, 99
bill of materials, 106
binaries, 38
Blender, 35
bottle, 103
Budaschnozzle, 106
burns, x
bushings, 98

C

CAD, 28, 35
calibration, 106
community support, 108
configuration, 29
 export, 82
 import, 82
connecting, 31

cooling, 77

D

download, 28, 29, 38, 99, 106
drivers, 28

E

electronics, x, 100, 106
electronics receptacles, 19
end stops, 23, 33
extrude, 33
extruder, x, 30
extruder jam, 99
extrusion, 30

F

fan, 100
feed tube, 90
filament, 92
filament spool, 88
forums, 108
FreeCAD, 35
Freenode, 108

G

gcode, 28, 30, 34, 106
github, 38
glass, 98
GNU/Linux, 28, 31, 35, 36

H

hardware, 106
hazards, x
heater block, x, 102
high resolution, 102
hobbed bolt, 99
home, 33
hot end, 32, 33, 92, 100, 102

I

infill, 68
IRC, 108

L

latex, 38, 106
Linux, 28
load files, 34
lubricant, 98

M

maintenance, 98
manual controls, 33
Marlin, 106
motors, 33

N

novelties, 106
nozzle, 102

O

OpenSCAD, 36
operating system, 28
OSX, 28

P

PET sheet, 98, 103
plater, 30
port, 31
power supply, x, 19
printed parts, 106

Printrun, 30–32, 34, 106
profiles, 83
 create, 83
 delete, 84
pronterface, 31
PTFE tube, 22

R

RAMBo, 22, 100, 106
RepRap, 108
resolution, 28

S

SD card, 30
Shapesmith, 35
Slic3r, 28, 106
smooth rods, 98
software, 28, 35, 99, 106
source, 38
source code, 38, 106
speed, 66
spool, 88
static, xi
STL, 28, 30, 35, 106
support, 80

T

technical support, 108
temperature, x, 30, 32, 92
threaded extension, 102

U

USB cable, 19, 31

W

warnings, x
warping, 103
Windows, 28, 35, 36
wing nuts, 88

INDEX

wires, x
wrench, 102

X

X axis, 33

Y

Y axis, 33

Z

Z axis, 33

GLOSSARY

.gcode *The file extension for G-Code files*

3D Printer *Also referred to as additive manufacturing, is the process of fabricating objects from 3D model data, through the deposition of a material in accumulative layers.*

ABS *Acrylonitrile Butadiene Styrene thermoplastic. Usually extrudes at 230C.*

Acetone *A colorless, volatile, flammable liquid ketone, (CH₃)₂CO, used as a solvent for ABS.*

Baud Rate *Refers to the speed at which the host controller communicates with the 3d Printer electronics.*

CAD *Computer Aided Design*

End stops *Mechanical or optical switches that are used to mark the 3 home (zero) positions.*

Filament *Plastic material in string like form, as is fed to the printer.*

free/libre *Free/Libre hardware and software can be thought of as free as in free speech, not just free as in free beer, although most free/libre software is available for no cost. Libre hardware designs can be copied, modified and are usually available for download. Free/Libre software can be used in a similar fashion.*

GCODE *The common name for the most widely used CNC programming language.*

HDPE *High Density Polyethylene.*

Heater block *Machined from Aluminium, the heater block generates heat with a heater resistor and uses a thermistor to measure the temperature.*

GLOSSARY

Heater resistor *A special type of resistor that is used to apply heat in a small area.*

HIPS *High Impact Polystyrene.*

Hot end *The hot end is the whole part where the plastic melts, including the nozzle, heater block, thermistor, and heat sink. The Budaschnozzle is LulzBot's™ hot end.*

Idler *Refers to parts using a bearing (usually a 608ZZ) to add tension in belts or to add pressure against a rolling surface.*

Layer height *The thickness of each individual deposited layer of the three dimensional model when cut with a slicing program.*

Laywoo-D3 *Wooden filament similar to PLA. Contains 40 percent recycled wood. Usually prints at 180C- 210C. Color can be changed by varying the extrusion temperature.*

Nozzle *The metal tip at the bottom of the hot end. It has a small hole where the plastic filament comes out of the printer.*

PEEK *Polyether ether ketone- an organic polymer used to insulate the hot end due to it's mechanical properties at elevated temperatures.*

PET *Polyethylene terephthalate.*

PLA *Polylactic Acid is a corn-based biodegradable polymer. Usually extrudes at 185C.*

Polycarbonate *A strong and impact resistant thermoplastic. Usually extrudes at 300C.*

RAMBo *[R]epRap [A]]duino-[M]ega compatible [M]other [Bo]ard. Designed by Joynnyr of Ultimachine.*

Spool *Plastic Filament coiled and stored on a plastic reel. Preferred due to improved feeding and better mounting options.*

STL *Stereolithography file, also known as Standard Tessellation Language, and STL file is the common 3D model file format.*

Thermistor *A special type of resistor that changes resistance based on temperature. It is used to measure temperature on the nozzle and the heated bed.*

Threaded extension *Used to separate the heater block and nozzle from the PEEK insulator. The plastic filament passes through the threaded extension into the melting chamber.*

Colophon

Created with 100% Free/Libre Software

GNU/Linux
L^AT_EX Memoir
